

GEMSY

使用说明书·零件样本
User Manual & Parts List

500系列

平台式高速绷缝机

Three Needle Five Thread
Flat-bed Interlock

非常感谢您购买本公司的工业缝纫机。在使用缝纫机之前，请仔细阅读<为了您的安全使用>和使用说明书。

工业缝纫机的特性之一，是要在机针和旋梭等运动零部件附近进行操作，而这些零部件很容易引起受伤的危险，所以请在接受过培训的人员或有熟练操作技术的人员的指导下，正确地使用本缝纫机。



为了您的安全使用

1. 安全使用的标记及其意义

本使用说明书及产品所使用的标记和图案记号是为了您的安全而正确地使用本产品，防止您及他人受到危害和损害。

表示方法及含义如下：

说明

 危险	如果忽视此标记而进行了错误的操作，必将导致人员死亡或重伤。
 注意	如果忽视此标记而进行了错误的操作，有可能会引起人员受伤及造成设备损坏。

图案和符号



符号△表示“应注意事项”。
三角中的图案表示必须要注意的内容。
(如左图的符号表示“注意受伤”。)



符号⊘表示“禁止”。



符号●表示“必须”。
圆圈中的图案表示必须要做的内容。
(如左图的符号表示“必须接地”。)

Thank you very much for buying our sewing machine. Before using your new machine, please read the safety instructions below and the explanations given in the Operation Instruction.



With industrial sewing machines, it is normal to carry out work while positioned directly in front of moving parts such as the needle and thread take-up lever, and consequently there is always a danger of injury that can be caused by these parts. Follow the instructions from training personnel and instructors regarding safe and correct operation before operating the machine so that you will know how to use it correctly.

SAFETY INSTRUCTIONS

1. Safety indications and their meanings

This instruction manual and the indications and symbols that are used on the machine itself are provided in order to ensure safe operation of this machine and to prevent accidents and injury to yourself or other people. The meaning of these indications and symbols are given below.

Indications

	DANGER	The instructions which follow this term indicate situations where failure to follow the instructions will almost certainly result in death or severe injury.
	CAUTION	The instructions which follow this term indicate situations where failure to follow the instructions could cause injury when using the machine or physical damage to equipment and surroundings.

Symbols



..... This symbol (\triangle) indicates something that you should be careful of. The picture inside the triangle indicates the nature of the caution that must be taken. (For example, the symbol at left means "beware of injury".)



..... This symbol (\ominus) indicates something that you must not do.



..... This symbol (\bullet) indicates something that you must do. The picture inside the circle indicates the nature of the thing that must be done. (For example, the symbol at left means "you must make the ground connection".)

⚠ 危险



打开控制箱盖时，必须先关闭电源开关并将电源插头从插座上拔下，至少等待5分钟后，再打开控制箱盖。触摸带有高电压的区域将会造成人员伤亡。

⚠ 注意

使用环境



应避免在强电气干扰源(如高频焊机)的附近使用缝纫机。强电气干扰源可能会影响缝纫机的正确操作。



缝纫机的最佳工作环境是相对湿度在45%-85%的范围内，干燥或潮湿的环境均会影响缝纫机的正确操作。



电源电压的波动应该在额定电压的±10%以内的环境下使用。电压大幅度的波动会影响缝纫机的正确操作。



使用时应避免暴露于直射的阳光下。直射的阳光会影响缝纫机的正确操作。



电源容量应大于缝纫机的消耗能量。电源容量不足会影响缝纫机的正确操作。



万一发生雷电暴风雨时，关闭电源开关，并将电源插头从插座上拔下。雷电可能会影响缝纫机的正确操作。



环境温度应在5°C-35°C的范围内使用。低温或高温会影响缝纫机的正确操作。

安装



请让受过培训的技术人员来安装缝纫机。



固定电缆时，不要过度弯曲电缆或用卡钉固定得过紧，会引起火灾或触电的危险。



请委托购买商店或电气专业人员进行电气配线。



如果使用带小脚轮的工作台，则应该固定小脚轮，使其不能移动。



缝纫机重约40公斤，安装工作必须由两人以上来完成。



缝纫机头倒下或竖起时，请用双手进行操作。单手操作时因缝纫机的重量万一滑落易导致受伤。



在安装完成前，请不要连接电源，如果误按启动开关，缝纫机动作会导致受伤。



使用润滑油或黄油时，务必戴好保护眼镜和保护手套等，以防润滑油落入眼中或沾在皮肤上，这是引起发炎的原因。另外，润滑油或黄油不能饮用，否则会引起呕吐和腹泻。将油放在小孩拿不到的地方。



请在切断电源后，再拔掉电源插头。不然易成为控制箱发生故障的原因。



必须接地。接驳地线不牢固，是造成触电或误动作的原因。

DANGER



Wait at least 5 minutes after turning off the power switch and disconnecting the power cord from the wall outlet before opening the face plate of the control box. Touching areas where high voltages are present can result in severe injury.

CAUTION

Environmental requirements



Use the sewing machine in an area which is free from sources of strong electrical noise such as high-frequency welders. Sources of strong electrical noise may cause problems with correct operation.



Any fluctuations in the power supply voltages should be within $\pm 10\%$ of the rated voltage for the machine. Voltage fluctuations which are greater than this may cause problems with correct operation.



The power supply capacity should be greater than the requirements for the sewing machine's electrical consumption. Insufficient power supply capacity may cause problems with correct operation.



The ambient temperature should be within the range of 5°C to 35°C during use. Temperatures which are lower or higher than this may cause problems with correct operation.



The relative humidity should be within the range of 45% to 85% during use, and no dew formation should occur in any devices. Excessively dry or humid environments and dew formation may cause problems with correct operation.



Avoid exposure to direct sunlight during use. Exposure to direct sunlight may cause problems with correct operation.



In the event of an electrical storm, turn off the power and disconnect the power cord from the wall outlet. Lightning may cause problems with correct operation.

Installation



Machine installation should only be carried out by a qualified technician.



Contact your dealer or a qualified electrician for any electrical work that may need to be done.



The sewing machine weighs approximately 40kg. The installation should be carried out by two or more people.



Don't connect the power cord until installation is complete, otherwise the machine may operate if the foot switch is depressed by mistake, which could result in injury.



Be sure to connect the ground. If the ground connection is not secure, you run a high risk of receiving a serious electric shock, and problems with correct operation may also occur.



Install the safety covers to the machine head and motor.



Hold the machine head with both hands when tilting it back or returning it to its original position. Furthermore, after tilting back the machine head, do not push the face plate side or the pulley side from above, as this could cause the machine head to topple over, which may result in personal injury or damage to the machine.



All cords should be secured at least 25mm away from any moving parts. Furthermore, do not excessively bend the cords or secure them too firmly with staples, otherwise there is the danger that fire or electric shocks could occur.



If using a work table which has casters, the casters should be secured in such a way so that they cannot move.



Be sure to wear protective goggles and gloves when handling the lubricating oil and grease, so that they don't get into your eyes or onto your skin, otherwise inflammation can result. Furthermore, do not drink the oil or eat the grease under any circumstances, as they can cause vomiting and diarrhoea. Keep the oil out of the reach children.

注意

缝纫

 本缝纫机仅限于接受过安全操作培训的人员使用。



为了安全起见，在使用本缝纫机之前，请安装保护装置。如果未安装这些安全装置就使用缝纫机，会造成人身伤害及缝纫机损坏。

 本缝纫机不能用于除缝纫以外的任何其他用途。



缝纫过程中不要触摸任何活动部件或将物件靠在运动部件上，因为这会导致受伤或缝纫机损坏。

 发生下列情况时，请切断电源。否则误按动启动开关，缝纫机动作会导致受伤。

- 机针穿线时
- 更换机针或梭芯时
- 缝纫机不使用，或人离开缝纫机时



如果缝纫机操作中发生误动作，或者听到异常的噪声或闻到异常的气味，应立即切断电源。然后与购买商店或受过培训的技术人员联系。

 如果使用带小脚轮的工作台，则应该固定小脚轮，使其不能移动。



如果缝纫机出现故障时，请与购买商店或受过培训的技术人员联系。

清洁



在开始清洁作业前，请切断电源。如果误踩了脚开关，缝纫机动作会导致人员受伤。



使用润滑油或黄油时，务必戴好保护眼镜和保护手套等，以防润滑油落入眼中或沾在皮肤上，这是引起发炎的原因，另外，润滑油或黄油不能饮用，否则会引起呕吐和腹泻。
将油放在小孩拿不到的地方。

CAUTION

Sewing



This sewing machine should only be used by operators who have received the necessary training in safe use beforehand.



If using a work table which has casters, the casters should be secured in such a way so that they cannot move.



The sewing machine should not be used for any applications other than sewing.



Attach all safety devices before using the sewing machine. If the machine is used without these devices attached, injury may result.



Be sure to wear protective goggles when using the machine.

If goggles are not worn, there is the danger that if a needle breaks, parts of the broken needle may enter your eyes and injury may result.



Do not touch any of the moving parts or press any objects against the machine while sewing as this may result in personal injury or damage to the machine.



Turn off the power switch at the following times, otherwise the machine may operate if the foot switch is depressed by mistake, which could result in injury.

- When threading the needle
- When replacing the needle and bobbin
- When not using the machine and when leaving the machine unattended



If an error occurs in machine operation, or if abnormal noises or smells are noticed, immediately turn off the power switch. Then contact your nearest dealer or a qualified technician.



If the machine develops a problem, contact your nearest dealer or a qualified technician.

Cleaning



Turn off the power switch before carrying out cleaning, otherwise the machine may operate if the foot switch is depressed by mistake, which could result in injury.



Be sure to wear protective goggles and gloves when handling the lubricating oil and grease, so that they do not get into your eyes or onto your skin, otherwise inflammation can result. Furthermore, do not drink the oil or eat the grease under any circumstances, as they can cause vomiting and diarrhoea. Keep the oil out of the reach of children.

目录 CONTENTS

1. 供油	1
Lubrication	
2. 手动给油	1
Manual lubrication	
3. 给HR装置供油	2
Filling the HR device with silicon oil	
4. 穿线的方法	2
Threading diagram	
5-1. 穿线图(2针、3针)	3
Threading diagram	
5-2. 穿线图(4针)	3
Threading diagram	
6. 压脚压力的调节	4
Adjusting the presser foot pressure	
7. 差动比的调节	4
Adjusting the diff feed ratio	
8. 针脚长度的调节	4
Adjusting the stitch length	
9. 线状态的调节	5
Adjusting the thread tension	
10. 缝纫机的清扫	5
Cleaning the machine	
11. 换针	5
Replacing the needle	
12. 检查机油的循环	6
Checking the oil circulation	
13. 油过滤器的检点与更换	6
Checking and replacing the oil filter	
14. 换机油	6
Replacing the oil	
15. 调整标准参数表	7
Adjusting dimentions	

1. 供油 Lubrication

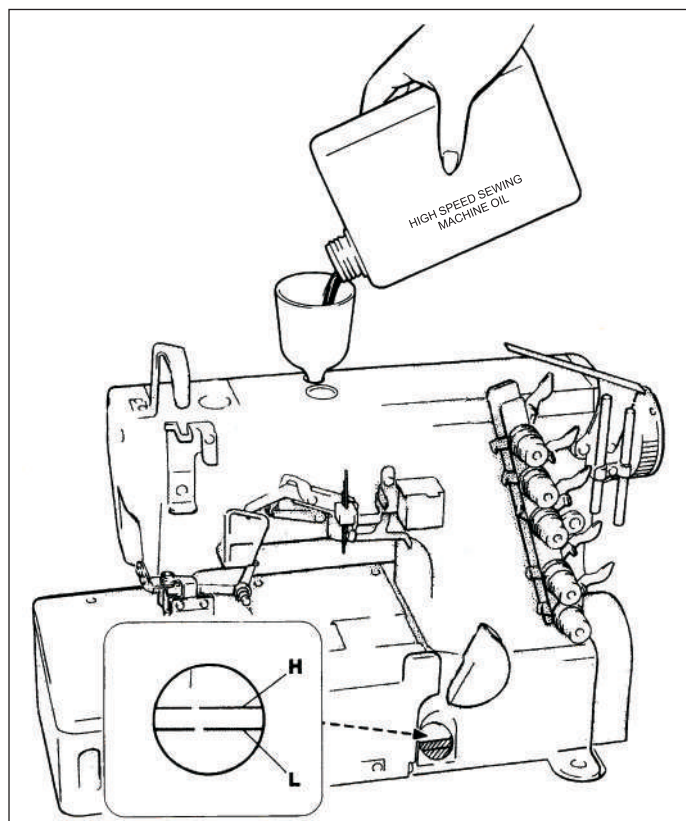

1. 加油量是使油面处于H线与L线之间为好. 当油面低于L线时, 就要及时补充机油.

EN

1. After filling the oil pan, the oil surface should lie between (H) and (L) lines.

Add oil, when the oil surface reaches or goes below (L).

2. 手动给油 Manual lubrication

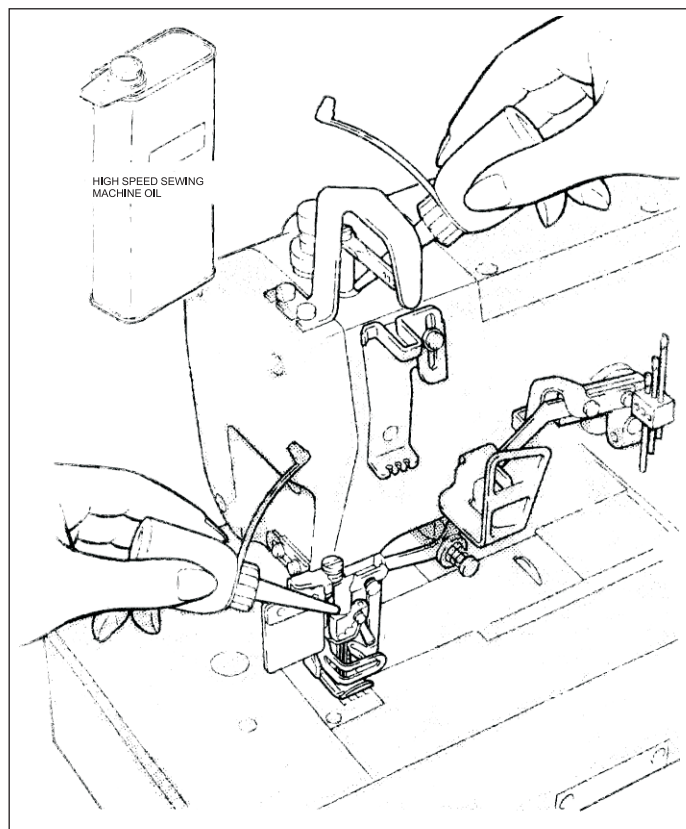

1. 手动给油是在缝纫机最开始使用时, 或停用一段时间重新开始使用时, 请供给2-3滴油.

EN

1. Apply 2 or 3 drops of oil by hand when the machine is used for the first time or has been left unused for some time.

3. 给HR装置供油 Filling the HR device with silicon oil

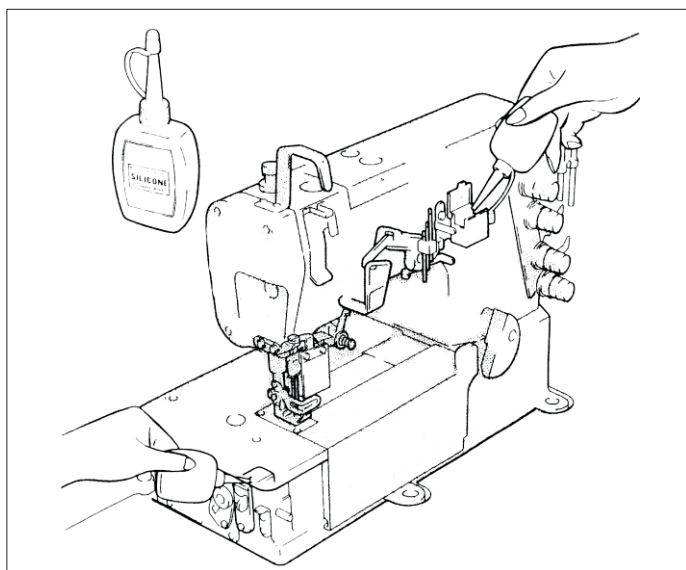

1. 为了防止布纤维或线被切断，请尽早给HR装置供油。
注：关于购买硅酯油，请咨询缝纫机代销店或本公司营业所联系。

EN

- 1) Fill the HR device with oil be for it is too low in order to prevent needle thread breakage and fabric damage.
Note: Use Pegasus recommended silicon oil. (UNION CARBIDE CORPORATION) UCC L-45 (350)

4. 穿线的方法 Threading

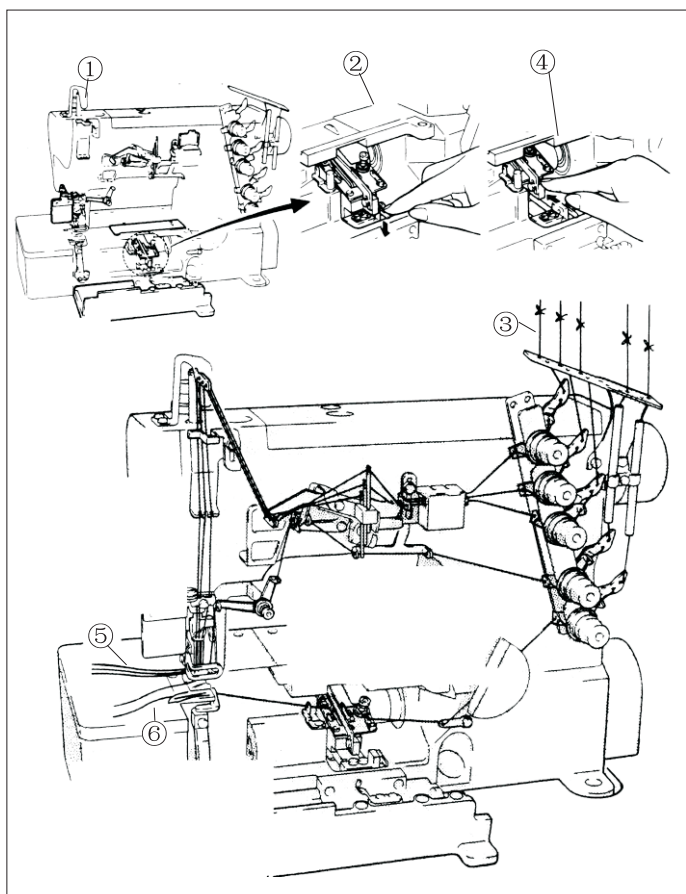

- 1) 请掀起护眼板, 打开机盖.
- 2) 摁压(弯针挑线器会跳出来)
- 3) 把机上原有的线与缝纫用线绑结在一起.
- 4) 穿好线后将弯针挑线器推回原位.
- 5) 针线(将线拉到针眼前, 剪掉接头再次穿好针线)
- 6) 弯针线上装饰线(直到拉出接头过来后, 用剪刀剪整齐接头, 整齐.
- 7) 若机上原来没有线, 请参照穿线图正确进行穿线.

EN

- 1) Open the guard and three covers.
- 2) Press down. (The looper thread take-up after threading.)
- 3) Kont the preset thread and the thread being used together to thread the machine.
- 4) replace the looper thread take-up after threading.
- 5) Needle thread Trim the knots off neatly before passing through the eye of the needle to rethread.
- 6) Looper thread , Top cover thread Trim the knots off neatly after passing through the eye of the looper.
- 7) Be sure to thread the machine correctly by referring to the threading diagram.

5-1. 穿线图(2针、3针) Threading diagram

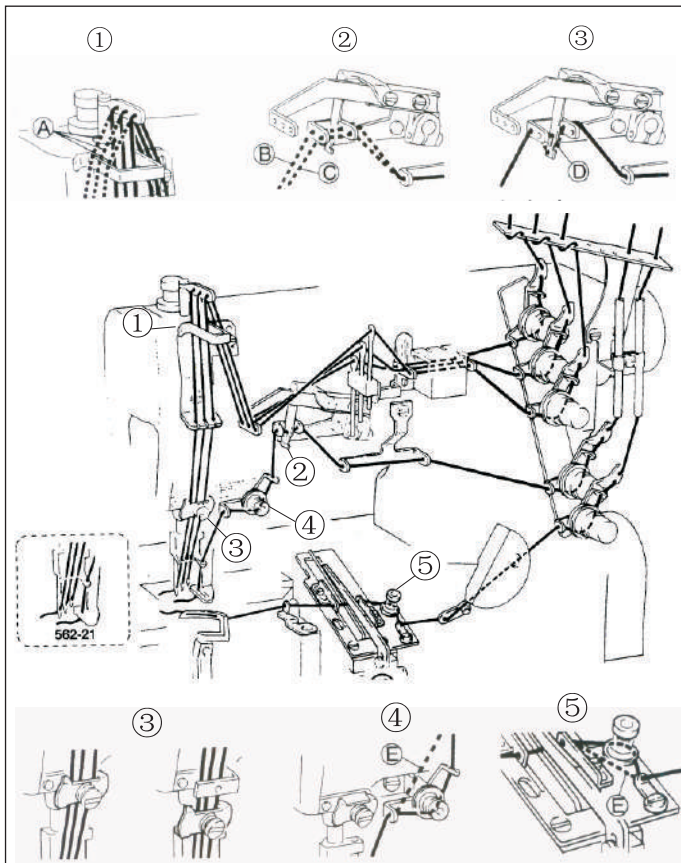

- ① 若使用伸缩大的线时,为点线 A 方向。
- ② 装饰线太松时用 B ,若用 B 还松时用 C 。
- ③-1 穿伸缩大的线时
- ③-2 穿伸缩小的线时
- ④穿伸缩大的线时用点 E 的方向。

EN

- ①Broken lines A , for more stretch able thread.
- ②In the top cover thread is too loose, use broken line B .If the top cover thread is still too loose after threading with broken line B ,use broken line C .
- ③-1 For more stretch-able threads.
- ③-2 For less stretch-able threads.
- ④Broken lines E for more stretchable thread (Solid lines for ordinary thread).

5-2. 穿线图(4针) Threading diagram

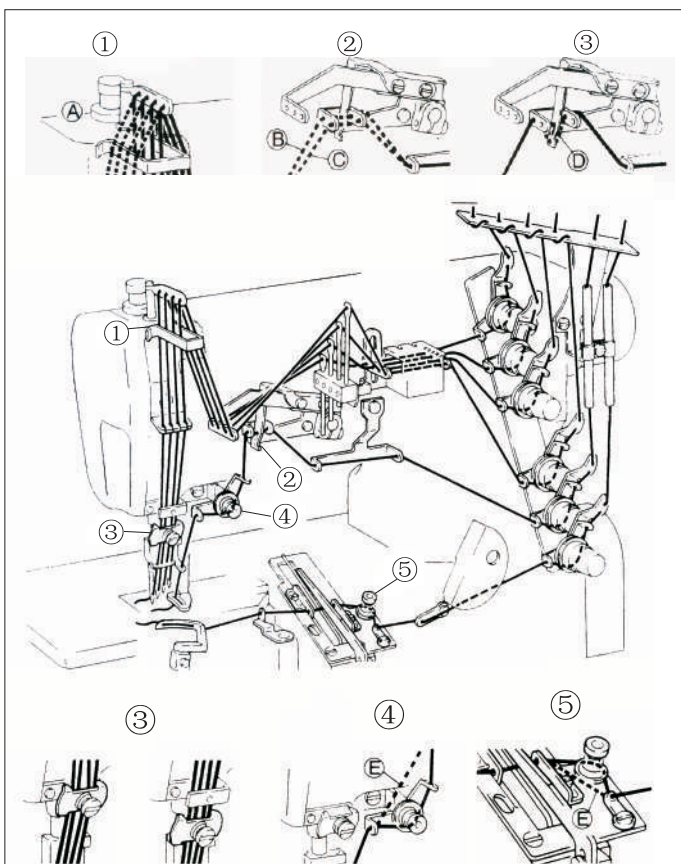

- ① 若使用伸缩大的线时,为点线 A 方向。
- ② 装饰线太松时用 B ,若用 B 还松时用 C 。
- ③-1 穿伸缩大的线时
- ③-2 穿伸缩小的线时
- ④穿伸缩大的线时用点 E 的方向。

EN

- ①Broken lines A , for more stretch able thread.
- ②In the top cover thread is too loose, use broken line B .If the top cover thread is still too loose after threading with broken line B ,use broken line C .
- ③-1 For more stretch-able threads.
- ③-2 For less stretch-able threads.
- ④Broken lines E for more stretchable thread (Solid lines for ordinary thread).

6. 压脚压力的调节 Adjusting the presser foot pressure

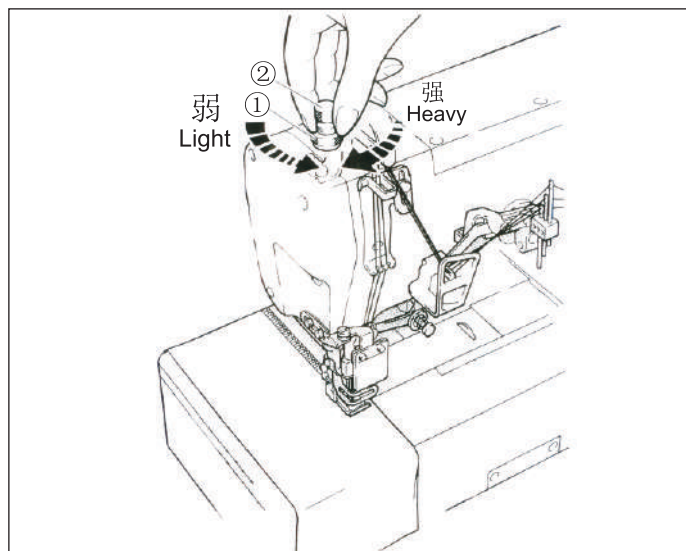

1) 压脚压力的调节是松开螺帽①和旋转螺丝②来进行的。在能取得平稳针脚的范围內，尽量调的松一些为好。

EN

1) Loosen adjusting nut ① and turn adjusting screw ② to adjust the presser foot pressure.

It should be as light as possible, yet be sufficient to obtain the proper stitch formation.

7. 差动比的调节 Adjusting the diff feed ratio

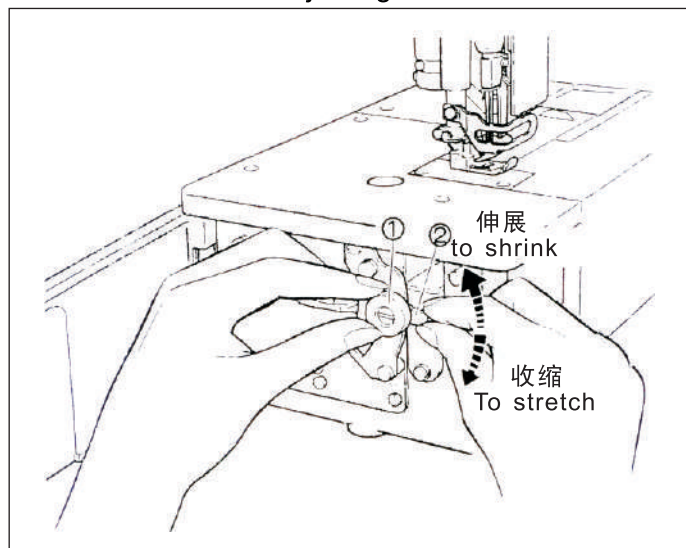

1) 差动比是通过松开螺帽①后，把调节杆②上下移动来进行调节的。调节后请拧紧螺帽①。

EN

1) Loosen the nut ① and move the lever up ② and down to obtain the correct differential feed ratio, then tighten nut ①.

8. 针脚长度的调节 Adjusting the stitch length

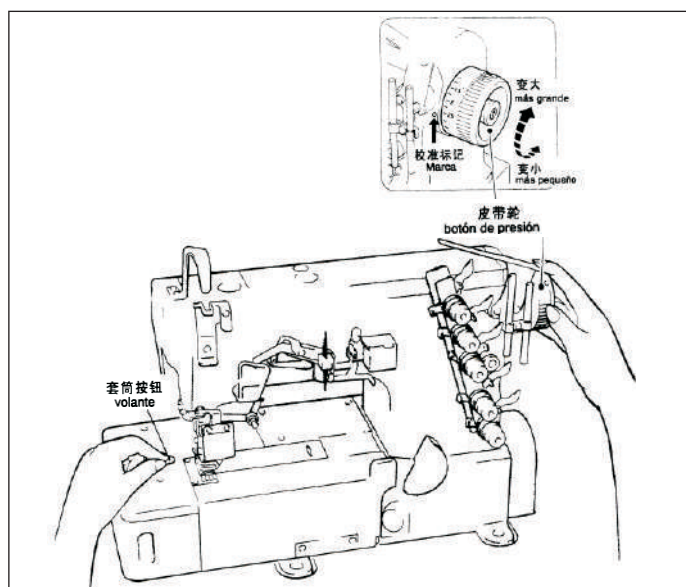

1) 摁住套筒按钮，旋转动皮带轮，套筒按钮会陷阱更深处。

2) 这时边摁住套筒按钮，边转动皮带轮，使校准标记对准希望的数值。

注：针脚长度的调节务必请在调节差动比之后进行调节。

EN

1) while pressing the button, turn the handwheel to seek the position at the push button goes further into the depth.

2) then, keeping the push button pressed, turn the handwheel and set the desired scale to the aligning mark.

Note: Stitch length adjustment must only be made after the differential feed ratio has been changed.

9. 线状态的调节 Adjusting the thread tension

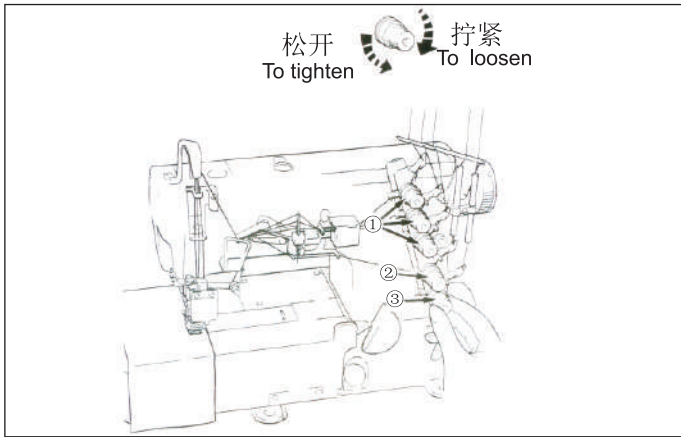

1) 线状态的调节是用针线状态螺帽①，上装饰状态螺帽②，下针状态螺帽③来进行调节。

EN

1) Make tension adjustments with the needle thread knob ①, the top cover thread knob ②, and the lower looper knob ③.

10. 缝纫机的清扫 Cleaning the machine

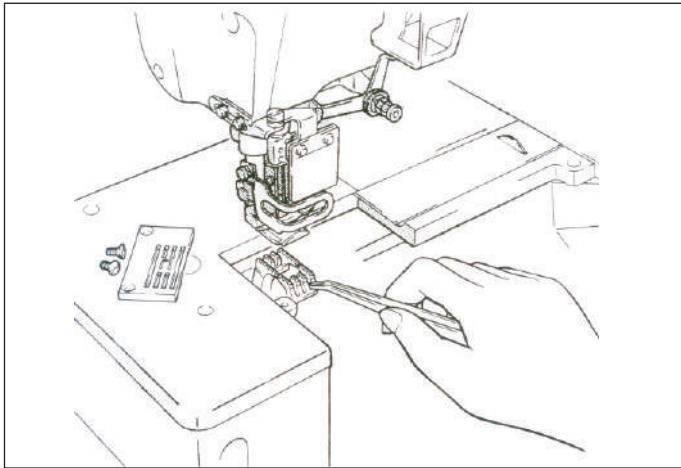

1) 缝纫机的清扫，以针板槽及送布牙周围为主。

EN

1) mainly the slots of the needle plate and the feed rows should be cleaned.

11. 换针 Replacing the needle

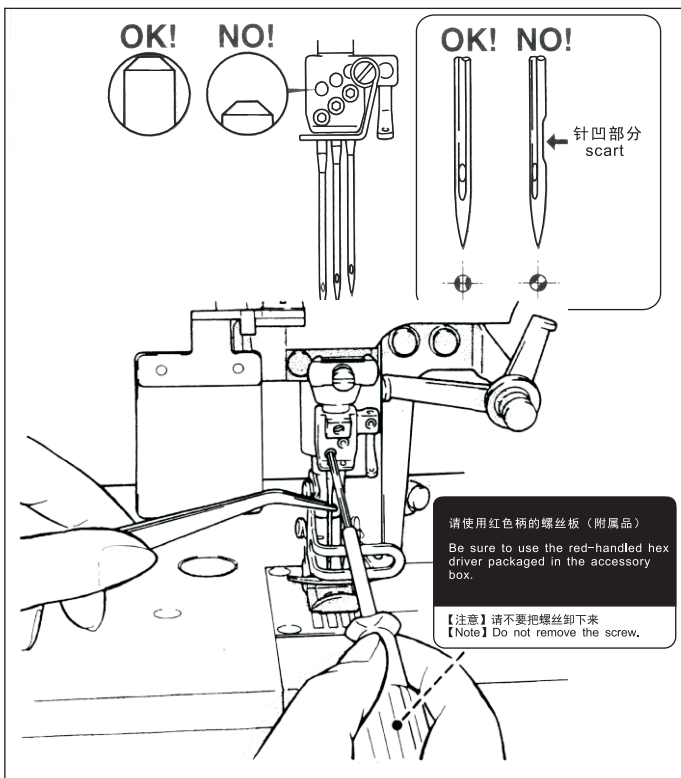

1) 准确辨认针的前后，请将针凹向着后方，即背向操作者进行安装。

2) 针要牢固的插到孔的最深处。

3) 标准使用的缝纫针，请参照卷中附有的“调整标准表”。

EN

1) Check the needle carefully to see that the scarf is turned to the rear of the machine.

2) Insert the needle to the proper depth, and fasten securely.

3) Be sure to use standard needle.

Refer to DJUSTMENT DIMENSIONS on the end of instructions.

12. 检查机油的循环 Checking the oil circulation



1) 检查机油的循环状况, 请在加好油后, 通过油窗检查机油的循环状况是否良好。

EN

1) Check the status of oil cycle, after adding the oil, please check the status of oil recycle through oil window.

13. 油过滤器的清洁与更换 Checking and replace the oil filter

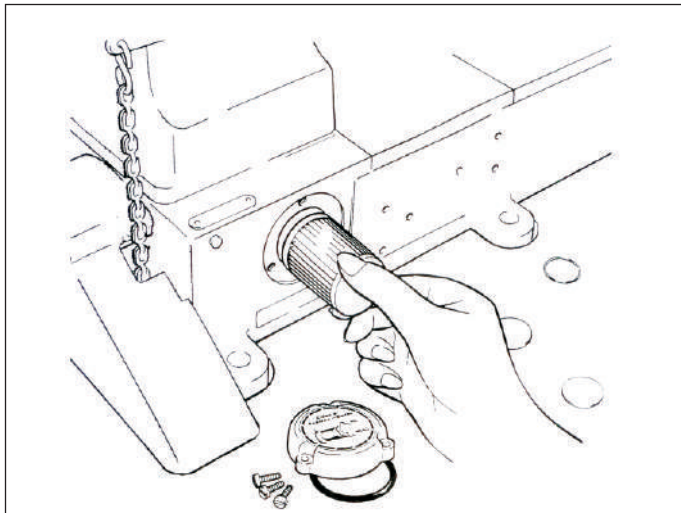

1) 机油过滤器, 请每隔6个月来清洁或更换一次。
注: 缝纫机附带有UT装置时, 请拆下螺线管托架。

EN

1) Check and replace the oil filter every six months.
NOTE: On machines fit with a UT device, remove the solenoid bracket.

14. 换机油 Replacing the oil

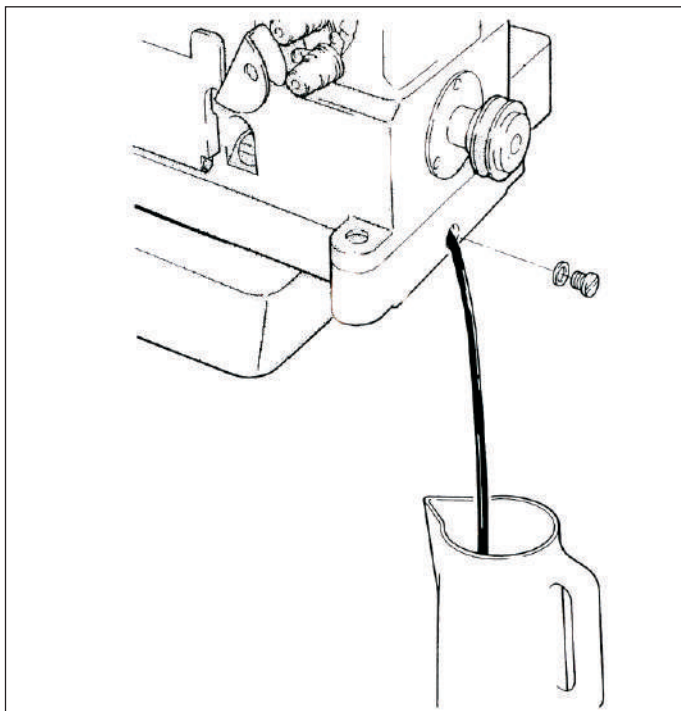

1) 机油的更换, 请在使用开始1个月以后更换一次, 然后, 每隔6个月更换一次。

EN

1) After using the machine for a month, please replace the oil, then replace the oil for each 6 months. if you continue to use the old oil, the sewing machine may malfunction.

15. 调整标准参数表 Adjustment dimentions

(mm)

	×□□□							
562-01C	224	10.2	4.8-5.1	8.3-8.7	4.5-5.0	17.0	0.8-1.2	
542 02B	232	9.8	4.4-4.7	8.3-8.7	4.5-5.0	17.0	0.8-1.2	
02S	240	9.3	4.0-4.3	8.3-8.7	4.5-5.0	17.0	0.8-1.2	
03D	248	8.9	3.6-3.9	8.3-8.7	4.5-5.0	17.0	0.8-1.2	
03E	256	8.5	3.2-3.5	8.3-8.7	4.5-5.0	17.0	0.8-1.2	
05B	264	8.1	2.8-3.1	8.3-8.7	4.5-5.0	17.0	0.8-1.2	
05C	348	9.4	3.6-3.9	8.8-9.2	4.5-5.0	17.0	0.8-1.2	
05S	356	8.5	3.2-3.5	8.3-8.7	4.5-5.0	17.0	0.8-1.2	
06B	364	8.1	2.8-3.1	8.3-8.7	4.5-5.0	17.0	0.8-1.2	
07B	460	9.3-9.8	2.8-3.1	8.7-9.2	4.8-5.2	17.2	0.8-1.2	
08A	232	9.3	4.4-4.7	7.8-8.2	4.5-5.0	17.0	0.8-1.2	
562-01G	240	8.8	4.0-4.3	7.8-8.2	4.5-5.0	17.0	0.8-1.2	
02D	356	9.3	3.7-4.0	9.7-10.2	4.5-5.0	17.0	1.2-1.5	
82A	364	8.8	3.3-3.6	9.7-10.2	4.5-5.0	17.0	1.2-1.5	

(mm)

	×□□□			
542-84A	232	9.8	4.4-4.7	0.8-1.2
522-04A	264	11.5	4.5-4.7	0.8-1.2
-04B	295	11.5	4.5-4.7	0.8-1.2

(mm)

	×□□□								
522-01F	264	11.0	4.0-4.5	9.4	5.0-5.5	20.5-21.0	0.8-1.2	0.5	0.5-1.0

零件目录 PARTS CONTENTS

1. 机壳部件(1) FRAME COMPONENTS(1)	9
2. 机壳部件(2) FRAME COMPONENTS(2)	11
3. 机壳部件(3) FRAME COMPONENTS(3)	13
4. 下轴部件 LOWER SHAFT COMPONENTS	15
5. 上轴部件 UPPER SHAFT COMPONENTS	17
6. 针杆部件 NEEDLE BAR COMPONENTS	19
7. 护针部件 NEEDLE GUARD COMPONENTS	21
8. 弯针部件 LOOPER COMPONENTS	23
9. 送布部件 MAIN FEED MECHANISM COMPONENTS	25
10. 差动部件 DIFFERENTIAL FEED MECHANISM COMPONENTS	29
11. 抬压脚部件 PREESSER FOOT LIFTER COMPONENTS	31
12. 绷针部件 STRETCH NEEDLE COMPONENTS	32
13. 过线器部件 THREAD GUIDE MECHANISM COMPONENTS	35
14. 过线部件 THREAD GUIDE COMPONENTS	37
15. 下过线器部件 LOWER THREAD TENSION COMPONENTS	39
16. 供油部件 LUBRICATION MECHANISM COMPONENTS	41
17. 油泵部件 PUMP COMPONENTS	43
18. 机针冷却器部件 NEEDLE COOLING MECHANISM COMPONENTS	45
19. 线架部件 THREAD STAND COMPONENT	47
20. 附件 ACCESSORIES PARTS	49
21. 导布部件 FABRIC GUIDE COMPONENTS	51
22. (500B-02/02HY/02QG/02DN)专用部件 SPECIFIC PARTS (FOR 500B-02/02HY/02QG/02DN)	53
23. (500B-05)专用部件(1) SPECIFIC PARTS (1) (FOR 500B-05)	55
24. (500B-05)专用部件(2) SPECIFIC PARTS (2) (FOR 500B-05)	57
25. (500B-05)专用部件(3) SPECIFIC PARTS (3) (FOR 500B-05)	59
26. (500B-05)专用部件(4) SPECIFIC PARTS (4) (FOR 500B-05)	61
27. (500B-05)专用部件(5) SPECIFIC PARTS (5) (FOR 500B-05)	63
28. (500B-05)专用部件(6) SPECIFIC PARTS (6) (FOR 500B-05)	65
29. (500B-02HY)专用部件 SPECIFIC PARTS (FOR 500B-02HY)	67
30. (500B-04)专用部件 SPECIFIC PARTS (FOR 500B-04)	71
31. (500B-21)专用部件 SPECIFIC PARTS (FOR 500B-21)	73
32. (500A-01)专用部件 SPECIFIC PARTS (FOR 500A-01)	77

1. 机壳部件(1) FRAME COMPONENTS(1)

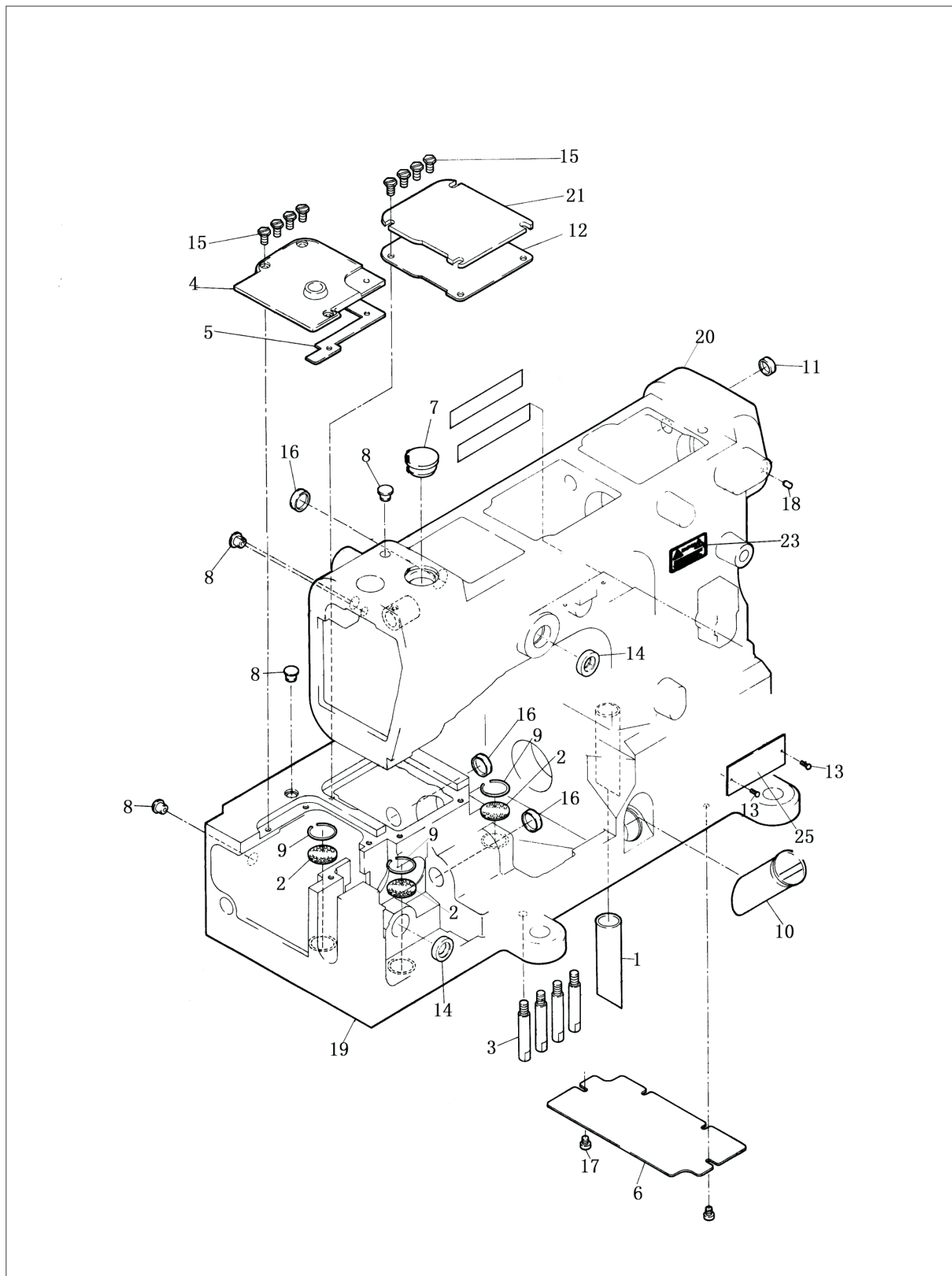

1. 机壳部件(1) FRAME COMPONENTS(1)

序号 NO.	注解 NOTE	图号 REF NO.	名称	DESCRIPTION	数量 AMT
1		301-01-01	机壳竖回油管	Machine Frame Oil Stand Pipe	1
2		301-01-02	过滤网20目	Filter Halftone	3
3		301-01-03	机座螺钉	Machine Mounting Screw	4
4		301-01-04	针距按钮盖	Push Button Cover (needle)	1
5		301-01-05	针距按钮盖防油垫	Oil Protecting Gasket	1
6		301-01-06	底罩板	Bed Hood Plate	1
7		301-01-07	闷头	Plug Stud	1
8		301-01-08	闷头	Plug Stud	4
9		28-16816200-08	挡圈内孔	Thread Take-up Lever Guard	3
10		301-01-10	油量指示窗	Oil Indication Window	1
11		301-01-11	闷头	Plug Stud	1
12		301-01-12	弯针传动盖油垫	Oil Gasket	1
13		101-01-14	铆钉 $\phi 2 \times 4$	Rivet $\phi 2 \times 3$	6
14		32-09440190-09	挑线轴骨架密封圈	Framework Airproof Ring	2
15		12-90400820-01	针距按钮盖螺钉	Push Button Cap Screw	8
16		301-01-14-2	防油圈	Oil Shield Coil Protecting Ring	3
17		12-40400525-01	螺钉	Screw	2
18		301-01-23	指示销	Direction Of Pin	1
19		301-01-27	机座	Machine Seat	1
20		301-01-28	机壳	Arm	1
21	#01	301-01-29	弯针传动仓板	Looper Driver Plate	1
22		44-00000003-41	机针标签 (UYX128GAS 11#)		1
23		44-00000001-00	注意牌	Plate With Notice	1
24		31-15026500-09	O型圈	O-ringn	1
25		301-01-33	型号牌	Plate With Model	1
26		41-20502500-00	拼装开口销 $\phi 5 \times 25$	Pin $\phi 5 \times 25$	2
27		12-61003022-01	拼装螺钉	Screw	4

Note:
#01...For -7不用

2. 机壳部件(2) FRAME COMPONENTS(2)

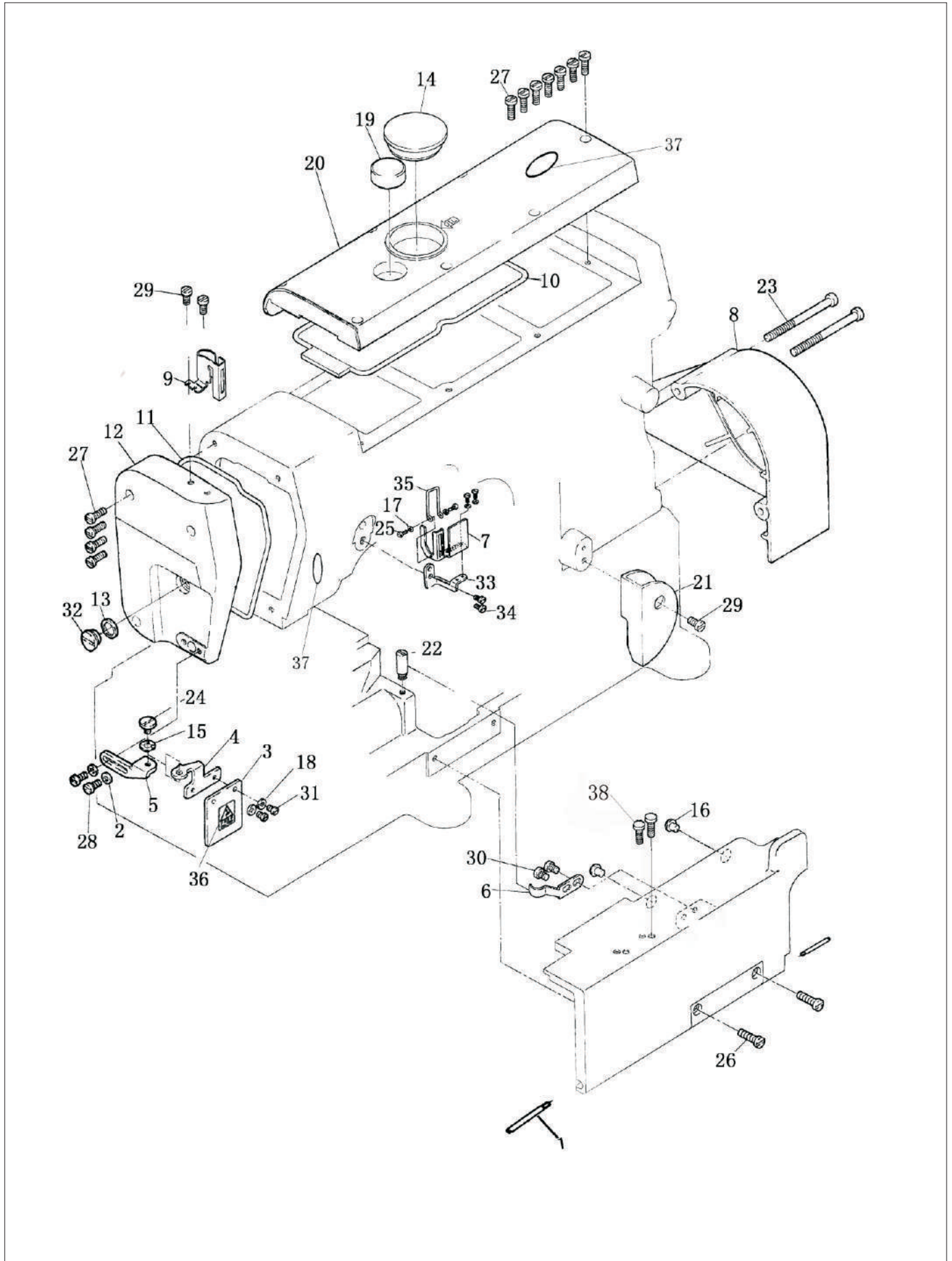

2. 机壳部件(2) FRAME COMPONENTS(2)

序号 NO.	注解 NOTE	图号 REF NO.	名称	DESCRIPTION	数量 AMT
1		301-02-01	穿线罩销轴	Threading Cover Pin	1
2	#02	21-04308090-02	垫圈	Washer	2
3	#02	301-02-03	防护罩	Shield	1
4	#02	301-02-04	防护罩支架	Shield Bracket	1
5	#02	301-02-05	防护罩座	Shield Seat	1
6		301-02-06	穿线罩弹簧	Threading Cover Spring	1
7	#03	340-02-07	挑线防护罩	Threading Cover Spring	1
8		301-02-08	皮带罩	Belt Guard	1
9	#04	340-02-09	上挑线座罩	Thread Take-up Lever Guard	1
10		301-02-10	上盖密封垫	Upper Cover Gasket	1
11		301-02-11	面板密封垫	Face Cover Gasket	1
12		301-02-12	面板	Face Cover	1
13		301-02-14	面板密封圈	Face Cover Seal Ring	1
14		301-02-15	上盖闷头	Upper Cover Plug	1
15	#02	23-06405110-09	鞍型垫圈	Wave Washer	1
16		301-02-17	防震塞	Shockproof Plug	2
17	#03	21-04308090-02	垫片	Washer	4
18	#05	21-03208070-02	防护罩垫圈	Shield Washer	2
19		301-02-20	喷油窗	Sight Window	1
20		301-02-21	上盖	Upper Cover	1
21		301-02-22	底线过线导板	Thread Eyelet Guide Plate	1
22		301-03-14	过线连接柱	Thread Handler Link	1
23		12-60506020-01	皮带罩螺钉一字槽	Belt Guard Screw	2
24	#02	301-02-25	防护罩铰链螺钉	Shield Hinge Screw	1
25	#03	12-40400625-01	螺钉	Screw	4
26		12-40401625-01	穿线罩铰链螺钉	Threading Cover Hinge Screw	2
27		12-40401225-01	上盖螺钉	Upper Cover Screw	11
28	#02	12-40400825-01	上挑线座罩螺钉	Silicone Oil Thread Stand Screw	2
29		12-40400825-01	上挑线罩螺钉	Screw	3
30		12-40400625-01	穿线罩弹簧螺钉	Threading Cover Spring Screw	2
31		12-40300625-01	防护罩螺钉	Shield Screw	2
32		301-02-33	面板螺钉	Face Cover Screw	1
33	#06	340-02-34	护板支架	Shield Bracket	1
34	#06	12-40601025-01	螺钉	Screw	2
35	#06	340-02-36	挑线防护罩钢丝	Steel Wire	1
36	#01	44-00000006-00	注意牌(安全)	Plate With Notice	1
37		44-00000004-00	注意牌	Plate With Notice	1
38	#07	12-40501125-01	螺钉	Screw	2

Note:

#01...For -7不用

#02...For -5、-4、-7不用

#03...For -5、-02HY不用

#04...For -02HY不用

#05...For -5、-4不用

#06...For -5、-02HY、-7不用

#07...For -1、500A-01专用

3. 机壳部件(3) FRAME COMPONENTS(3)

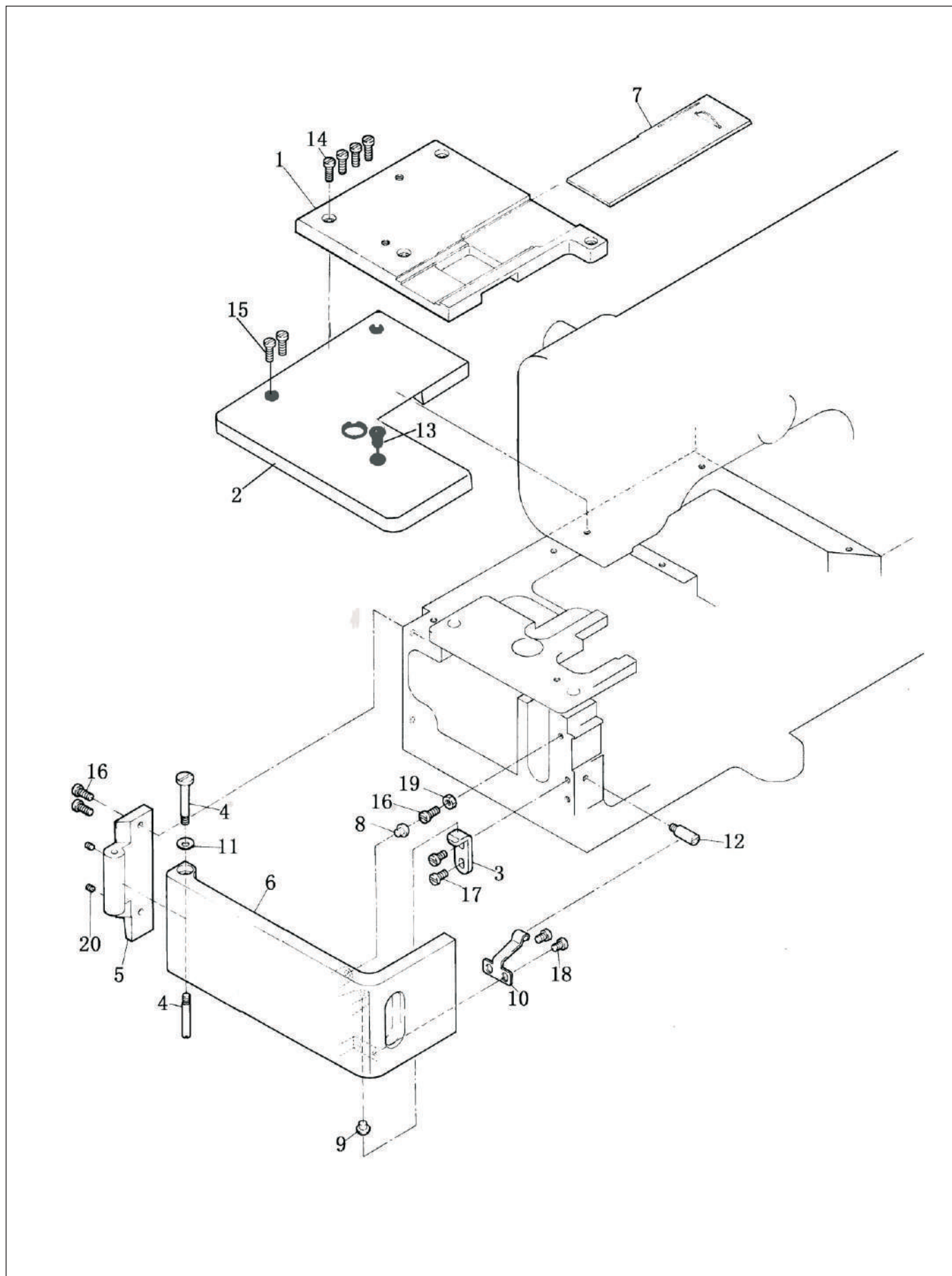

3. 机壳部件(3) FRAME COMPONENTS(3)

序号 NO.	注解 NOTE	图号 REF NO.	名称	DESCRIPTION	数量 AMT
1	#08	301-03-01	缝台上罩	Sewing Plate Uper Cover	1
2	#09	301-03-03	缝台前板	Sewing Plate Front Cover	1
3		301-03-04	防震板	Shockproof Board	1
4		301-03-06	铰链连接上螺钉	Hinge Link Screw	2
5		301-03-07	前罩铰链板	Hinge Board	1
6	#10	301-03-08	前罩	Frontal Mantle	1
7	#01、#04	301-03-09	推板	Slide Plate	1
	#30	338-03-09	推板	Slide Plate	1
8		301-02-17	防震塞	Shockproof Plug	1
9		301-02-17	防震塞	Shockproof Plug	1
10		301-03-12	前罩板弹簧	Frontal Mantle Spring	1
11		22-05000000-08	弹簧垫圈	Spring Washer	1
12		301-03-14	前罩板定位螺钉	Frontal Mantle Screw	1
13	#01	12-10400820-01	缝台前板沉头螺钉	Sewing Plate Front Cover Screw	1
14	#01	12-40401225-01	罩板螺钉	Mantle Plate Screw	4
15		12-40401225-01	缝台前板螺钉	Sewing Plate Front Cover Screw	2
16		12-40401025-01	铰链螺钉	Hinge Screw	3
17		12-40400825-01	防震板螺钉	Shockproof Board Screw	2
18		12-40400625-01	前罩螺钉	Frontal Mantle Screw	2
19		14-60403020-01	螺帽	Nut	1
20		12-80300412-01	铰链上头螺钉	Hinge Upper Screw	2

Note:
 #01...For -7不用
 #08...For 500A-01、-7不用
 #09...For -5、-7不用
 #10...For -5不用
 #30...For -02HY专用

4. 下轴部件 LOWER SHAFT COMPONENTS

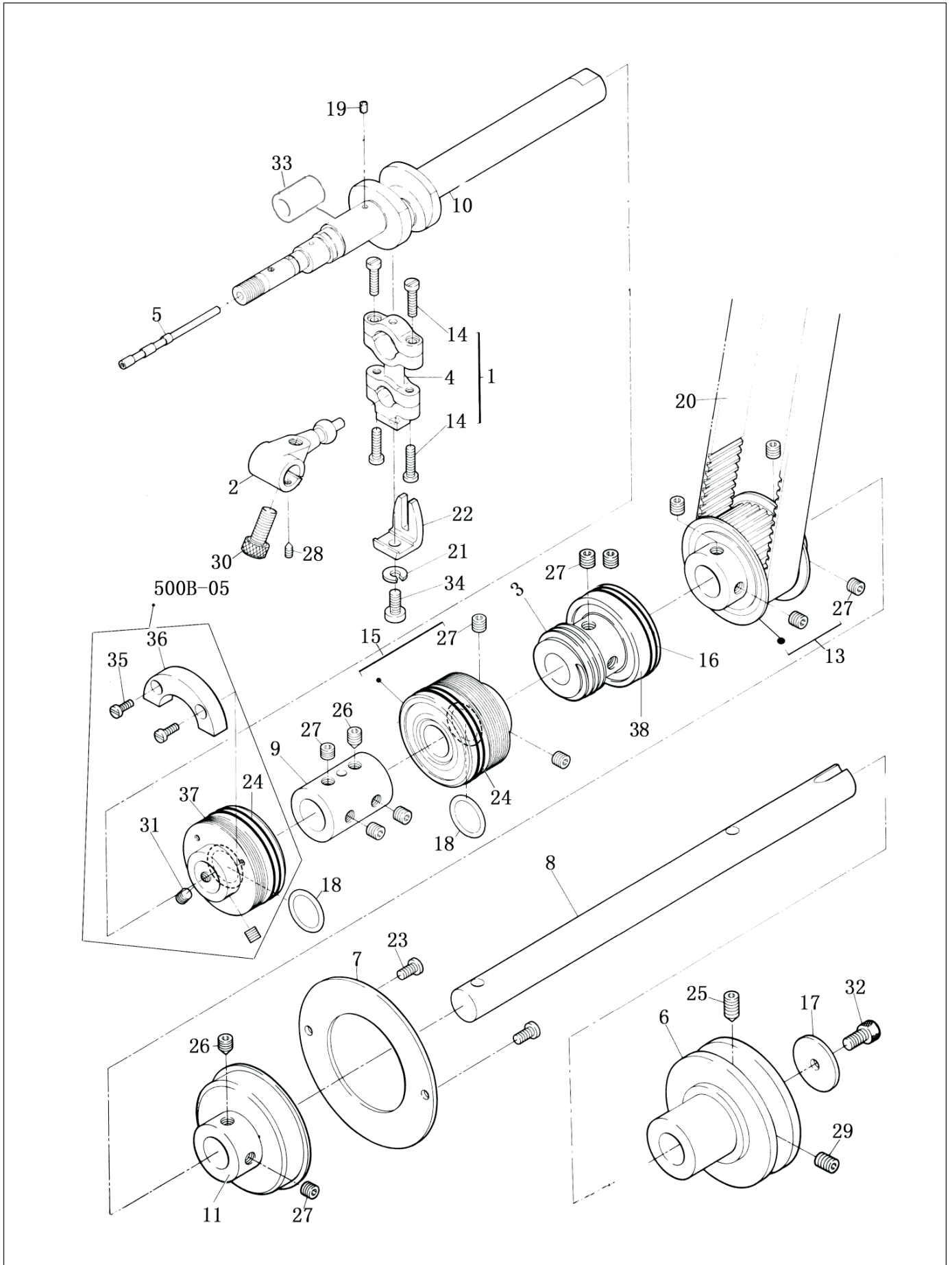

4. 下轴部件 LOWER SHAFT COMPONENTS

序号 NO.	注解 NOTE	图号 REF NO.	名称	DESCRIPTION	数量 AMT
1		301.04-01	弯针连杆组件(镀铜)	Looper Lever Complete	1
2		301.04-02	弯针球曲柄	Looper Ball Crank	1
3		301.04-03	油泵蜗杆	Oil Pump Worm	1
4		301.04-04	弯针连杆	Looper Lever Complete	-1
5		301.04-05	下轴油量调节芯针	Oil Flow Regulating Needle	1
6		301.04-06	从动轮	Traction Wheel	1
7	#11	301.04-17	压紧环	Impacted Loop	1
8		301.04-08	下轴后节轴	Lower Shaft Backside	1
9		301.04-09	联轴器	Link Bearing	1
10	#12	301.04-10	下轴前节	Lower Shaft Forepart	1
11	#12	301.04-11-00	下轴后衬套组件		1
		301.04-11	下轴后衬套	Lower Bearing Fittings Asm.	-1
		134.03-19	轴承 6304ZZNR	Lower Bearing Fittings Bearing	-1
		26-49010570-09	弹簧挡圈	Sprign Thrust Ring	-1
13		301.04-13	主动时规轮组件	Driving Wheel	1
14	#10	301.04-14	弯针连杆螺钉	Screw	-4
15		301.04-15	下轴中衬套组件	Lower Shaft Centre Bushing Asm.	1
		301.19-09	下轴中衬套轴承(6004)	Lower Shaft Centre Bushing Bearing	1
16		31-34518000-09	O型圈	O-ring	2
17		21-05220251-02	从动轮垫圈	Traction Wheel Washer	1
18		31-14818000-09	O型圈	O-ring	1
19		301.04-19	销子	Pin	-1
20		301.04-20	皮带 220×L075B	Belt 220×L075B	1
21	#10	22-05000000-08	开口垫圈	Snap Rign	1
22	#10	301.04-22	叉口	Fork	1
23	#13	12-10400820-01	压紧环螺钉	Impacted Loop Screw	2
24		31-32014000-09	O型圈	O-ring	2
25		12-80601042-01	从动轮定位螺钉	Traction Wheel Screw	1
26		12-85600842-01	联轴器定位螺钉锥端	Link Bearing Screw	2
27		12-85600512-01	螺钉	Screw	12
28	#10	12-80300442-01	球曲柄螺钉	Ball Crank Screw	1
29		12-80601012-01	从动轮定位螺钉	Traction Wheel Screw	1
30	#10	12-65601422-01	球曲柄螺钉	Ball Crank Screw	1
31	#13	12-80500512-01	前套螺钉	Front Bushing Screw	2
32		12-60501022-01	螺钉	Screw	1
33		301.04-35	下轴前套	Lower Shaft Front Bushing	1
34	#10	11-90110820-01	叉口螺钉	Fork Screw	1
35	#13	12-40300625-01	螺钉	Screw	2
36	#13	311.04-16-01	平衡块	Needle Driving Front Bearing	1
37	#13	311.04-16	下轴前衬套组件	Lower Shaft Front Bushing Asm.	1
	#13	301.19-09	下轴前衬套轴承	Lower Shaft Front Bushing Bearing	1
38		301.19-01-2	油泵蜗杆轴承(6204)	Oil Pump Worm Bearing	1

Note:
 #10...For -5不用
 #11...For 500A-01不用
 #12...For -21不用
 #13...For -5专用

5. 上轴部件 UPPER SHAFT COMPONENTS

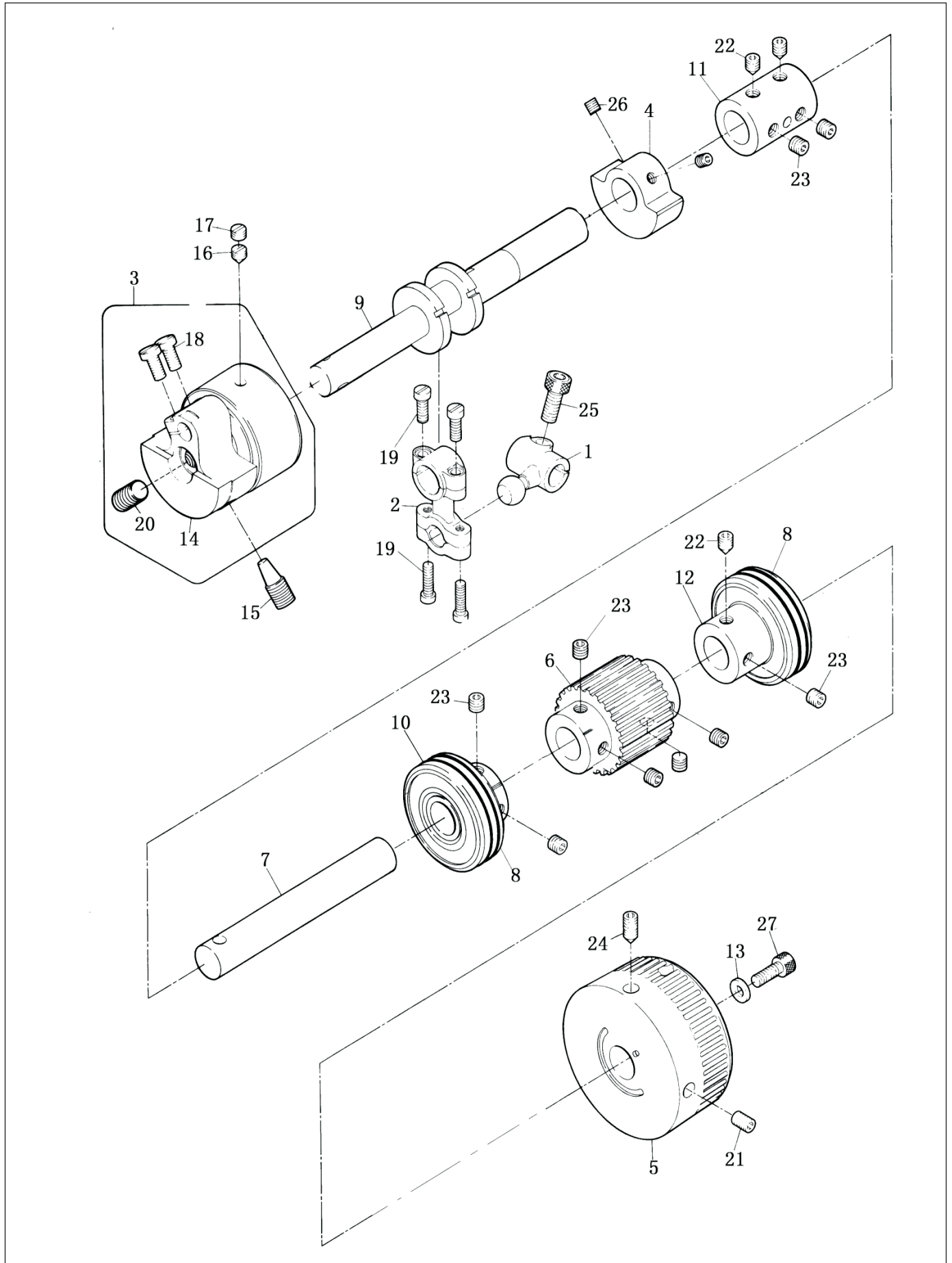

5. 上轴部件 UPPER SHAFT COMPONENTS

序号 NO.	注解 NOTE	图号 REF NO.	名称	DESCRIPTION	数量 AMT
1		301-05-01	上挑线球曲柄	Upper Tace-up Thread Ball Crank	1
2		301-05-02	上挑线连杆	Upper Tace-up Thread Link Lever	1
3		301-05-03	针杆曲柄组件	Needle Bar Crank Asm.	1
		301-19-02	6203ZZ轴承	Bearing	2
4		301-05-04	平衡块 (上)	Upper Balance Block	1
5	#10	301-05-05	上轮	Belt Wheel	1
6		301-05-06	从动时轮规	Follower Wheel	1
7	#10	301-05-07	上轴后节	Main Shaft Backside	1
8		31-34518000-09	O型圈	O-ring	4
9		301-05-09	上轴前节	Main Shaft Forepart	1
10	#10	301-05-10	上轴前衬套	Main Shaft Front Bushing	1
		301-19-01-2	上轴前衬套轴承 (6204)	Bearing	1
11		301-04-09	联轴器	Link Bearing	1
12		301-05-12	后衬套组件	Main Shaft Back Bushing Asm.	1
		301-19-01-2	后衬套轴承 (6204)	Bearing	1
13		21-05310100-02	上轮垫圈	Belt Wheel Washer	1
14	#12	301-05-14	针杆曲柄	Needle Bar Crank	1
15		12-85802032-01	定位螺钉长锥端紧定螺钉	Position Screw	1
16		12-85600630-01	定位螺钉	Screw	1
17		12-85600410-01	止夹螺钉	Screw	1
18		12-40501025-01	螺钉	Screw	2
19		12-40401225-01	连杆螺钉	Link Lever Screw	(4)
20		12-85801512-01	螺钉	Screw	1
21		12-80601042-01	上轮止夹螺钉	Belt Wheel Screw	1
22		12-85600842-01	后套定位螺钉尖端	Back Bushing Position Screw	3
23		12-85600512-01	螺钉	Screw	9
24		12-80601012-01	定位螺钉	Position Screw	1
25		12-65601422-01	球曲柄螺钉	Ball Crank Screw	1
26		12-80500512-01	平衡块螺钉	Balance Block Screw	2
27		12-60501622-01	上轮螺钉	Belt Wheel Screw	1

Note:
#10...For -5不用
#12...For -21不用

6. 针杆部件 NEEDLE BAR COMPONENTS

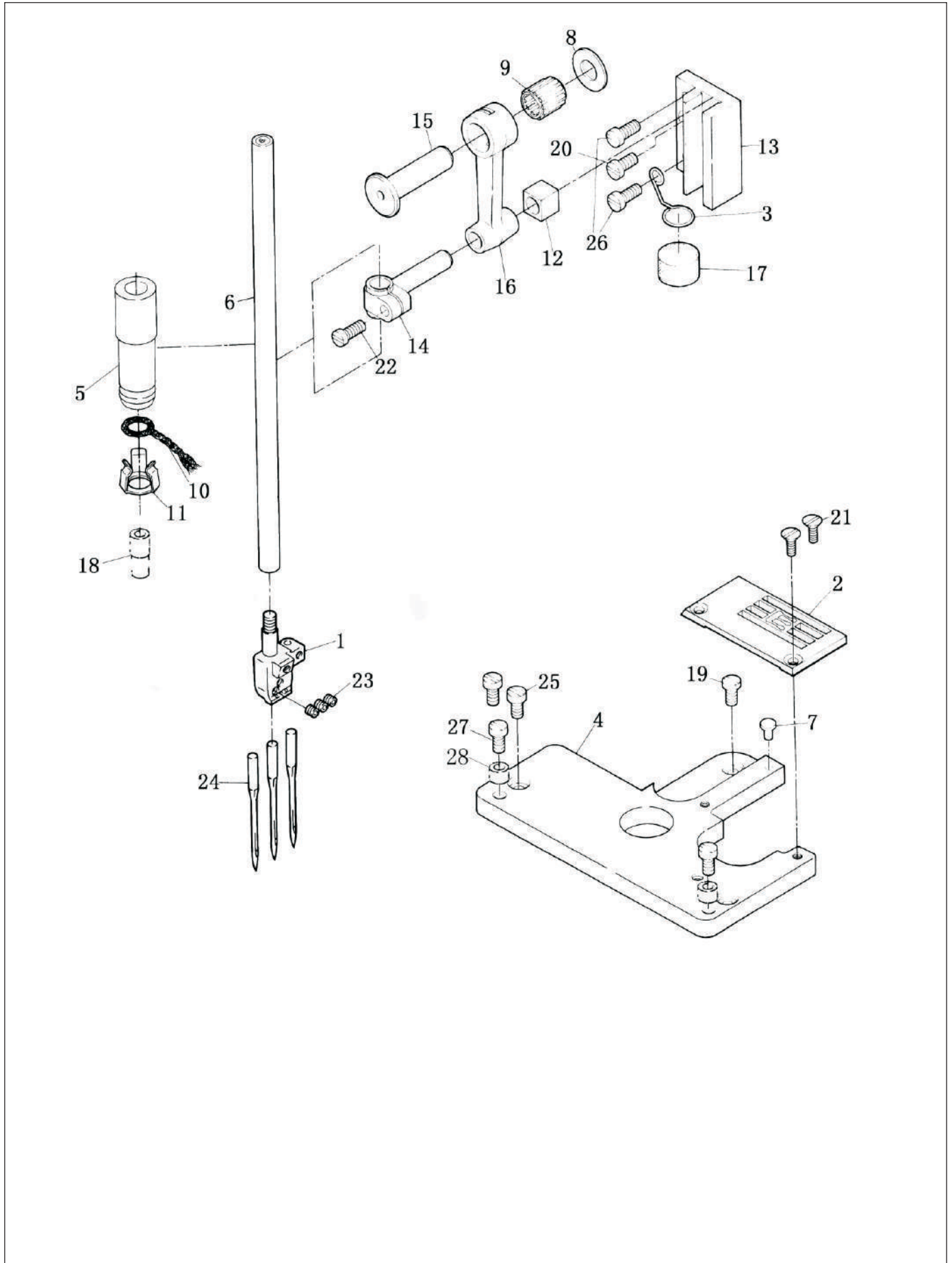

6. 针杆部件 NEEDLE BAR COMPONENTS

序号 NO.	注解 NOTE	图号 REF NO.	名称	DESCRIPTION	数量 AMT
1	#14	301-06-01	针夹	Needle Holder	1
	#16	312-06-01	针夹	Needle Holder	1
2	#15	301-06-02	针板	Needle Plate	1
	#16	312-06-02	针板	Needle Plate	1
3		301-06-03	油毡定位圈	Oil Felt Position Loop	1
4		301-06-04	针板接板	Needle Plate Link Plate	1
5		301-06-05	针杆上套	Needle Bar Upper Bushing	1
6		301-06-06	针杆	Needle Bar	1
7		301-06-07	防震塞	Shockproof Plug	1
8	#12	21-08210162-03	针杆连杆垫圈	Needle Bar Link Lever Washer	1
9		301-06-09	滚针轴承 $\Phi 8 \times \Phi 12 \times 12$	Needle Bearing $\Phi 8 \times \Phi 12 \times 12$	1
10		43-10250000-00	油线	Oil Wick	0.08
11		301-06-11	油线夹	Oil Wick Holder	1
12		301-06-12	针杆滑块	Needle Bar Slide Block	1
13		301-06-13	针杆滑块座	Needle Bar Slide Block Seating	1
14		301-06-14	针杆接头	Needle Bar Connecting Pole	1
15	#12	301-06-15	针杆连接销	Needle Bar Connecting Pin	1
16		301-06-16	针杆连杆	Needle Bar Link Lever	1
17		301-06-17	油毡	Oil Felt	1
18	#12	301-06-18	针杆下套	Needle Bar Lower Bushing	1
19		12-70400820-01	针板螺钉	Needle Plate Screw	1
20		12-40401025-01	螺钉	Screw	1
21		11-20090720-02	针板螺钉开槽半沉头	Needle Plate Screw	2
22		11-60111020-01	针杆接头螺钉	Needle Bar Connecting Screw	1
23		12-80300312-01	针夹螺钉	Needle Holder Screw	3
24	#12	301-06-24	机针	Needle	3
25		12-40400825-01	螺钉	Screw	2
26		12-40401225-01	螺钉	Screw	2
27		12-40400825-01	针板接板定位螺钉	Needle Plate Link Plate Pin	2
28		301-06-04-01	垫片	Washer	2

Note:
 #12...For -21不用
 #14...For -4、-6专用
 #15...For -02HY、-2、-5、-4、-3不用
 #16...For -6专用

7. 护针部件 NEEDLE GUARD COMPONENTS

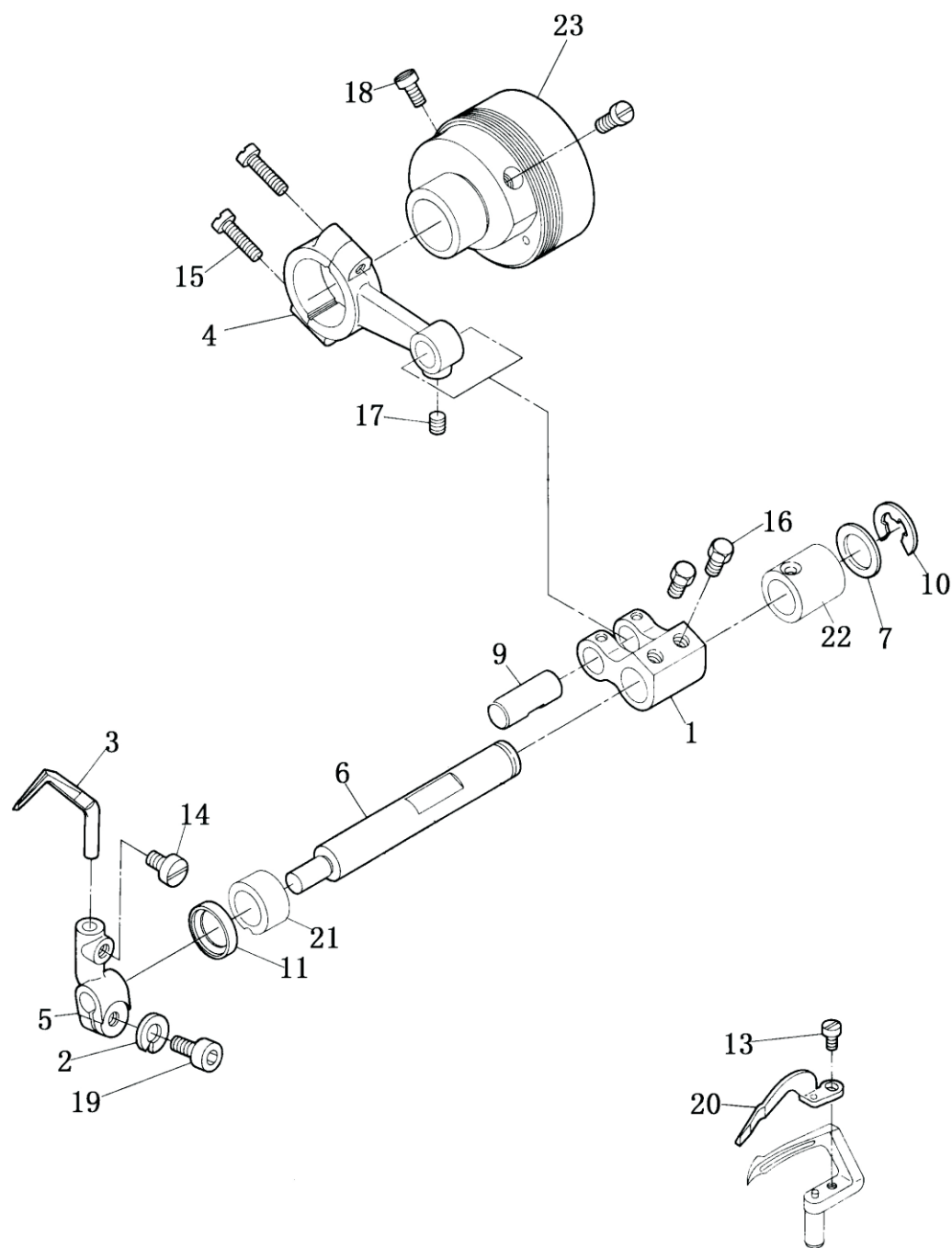

7. 护针部件 NEEDLE GUARD COMPONENTS

序号 NO.	注解 NOTE	图号 REF NO.	名称	DESCRIPTION	数量 AMT
1	#12	301-07-01	保针曲柄	Needle Guard Crank	1
2	#12	22-05000000-08	垫圈	Washer	1
3	#05	301-07-03	后保针	Rear Needle Guard	1
4	#12	301-07-04	保针连杆	Needle Guard Connecting Rod	1
5	#17	301-07-05	保针座	Needle Guard Base	1
6	#18	301-07-07	保针轴	Needle Guard Shaft	1
7	#12	21-10212142-01	垫圈	Washer	1
9	#12	301-07-10	保针曲柄销	Needle Guard Crank Pin	1
10	#12	24-07000000-09	开口挡圈	Snap Thrust Ring	1
11	#12	32-09430150-09	骨架防油圈	Framework Oil Shield	1
13	#19	12-40250425-01	保针螺钉	Needl Guard Screw	1
14	#19	12-40400625-01	螺钉	Screw	1
15	#12	11-40111425-01	保针曲柄螺钉	Needle Guard Connecting Rod Screw	(2)
16	#12	11-00110620-01	保针曲柄螺钉	Needle Guard Crank Screw	2
17	#12	12-80400412-01	螺钉	Screw	1
18	#12	12-80500612-01	螺钉	Screw	2
19		12-60501022-01	保针座螺钉	Needle Guard Base Screw	1
20	#05	301-07-21	前保针	Front Needle Guard	1
21	#12	301-07-23	保针轴左套	Needle Guard Shaft Left Bushing	1
22	#12	301-07-24	保针轴右套	Needle Guard Shaft Right Bushing	1
23	#10	301-04-16	下轴前衬套	Lower Shaft Front Bushing Asm.	1
24	#10	301-19-04	下轴前衬套轴承(6004)	Bearing(6004)	(1)
25	#10	31-14818000-09	O形圈	O-ring	(1)
26	#10	31-32014000-09	O形圈	O-ring	2

Note:
 #05...For -5、-4不用
 #10...For -5不用
 #12...For -21不用
 #17...For -5、-4、-21不用
 #18...For -5、-21不用

8. 弯针部件 LOOPER COMPONENTS

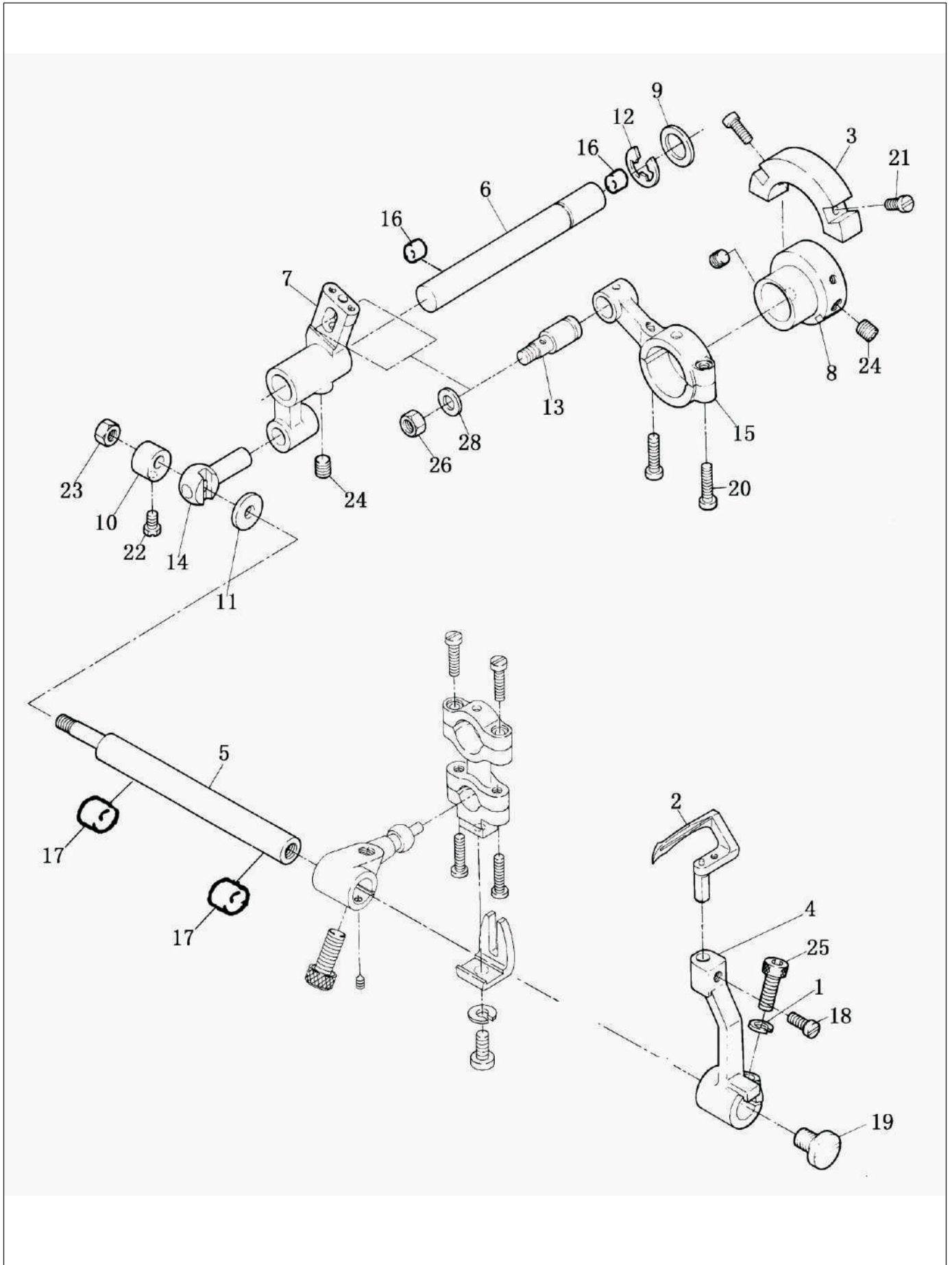

8. 弯针部件 LOOPER COMPONENTS

序号 NO.	注解 NOTE	图号 REF NO.	名称	DESCRIPTION	数量 AMT
1		22-05000000-08	垫片	Washer	1
2	#12	301.08-02	弯针	Looper	1
3	#10	301.08-03	平衡块(下)	Lower Balance Block	1
4	#20	301.08-04	弯针曲柄	Looper Crank	1
5	#19	301.08-05	弯针轴	Looper Shaft	1
6		301.08-06	弯针调节摆轴	Looper Regulate Driving Shaft	1
7		301.08-07	调节摆杆	Regulator Driving Bar	1
8	#18	301.08-08	偏心凸轮	Eccentricity Cam	1
9		21-10212142-01	垫圈	Washer	1
10		301.08-12	偏心紧圈	Eccentricity Thrust Ring	1
11		21-04615122-02	平垫圈	Washer	1
12		24-07000000-09	开口挡圈	Snap Thrust Ring	1
13		301.08-15	弯针调节柱	Looper Regulator Pole	1
14		301.08-16	接头	Connecting Pole	1
15	#18	301.08-17	弯针连杆组件	Looper Link Lever Asm.	1
16		301.07-24	弯针调节摆轴左/右套	Regulator Driving Shaft Bushing(left,right)	3
17		301.08-20	弯针轴前/后套	Looper Shaft Bushing (frong ,back)	1
18	#19	12-40400825-01	弯针刀槽螺钉	Looper Groove Screw	1
19	#19	12-75601020-01	弯针螺钉	Looper Screw	1
20	#18	11-40091425-01	连杆螺钉	Link Lever Screw	(2)
21	#10	12-40300625-01	平衡块螺钉	Balance Block Screw	2
22		11-90110820-01	紧圈螺钉	Thrust Ring Screw	1
23		14-60403020-01	螺帽	Nut	1
24		12-80500612-01	凸轮螺钉	Cam Screw	3
25		12-60501622-01	弯针曲柄螺钉	Looper Crank Screw	1
26		14-60504020-01	螺帽	Nut	1
28		21-05212121-03	垫圈	Washer	1

Note:
 #10...For -5不用
 #18...For -5、-21不用
 #19...For -4不用
 #20...For -4、-21不用

9. 送布部件 MAIN FEED MECHANISM COMPONENTS

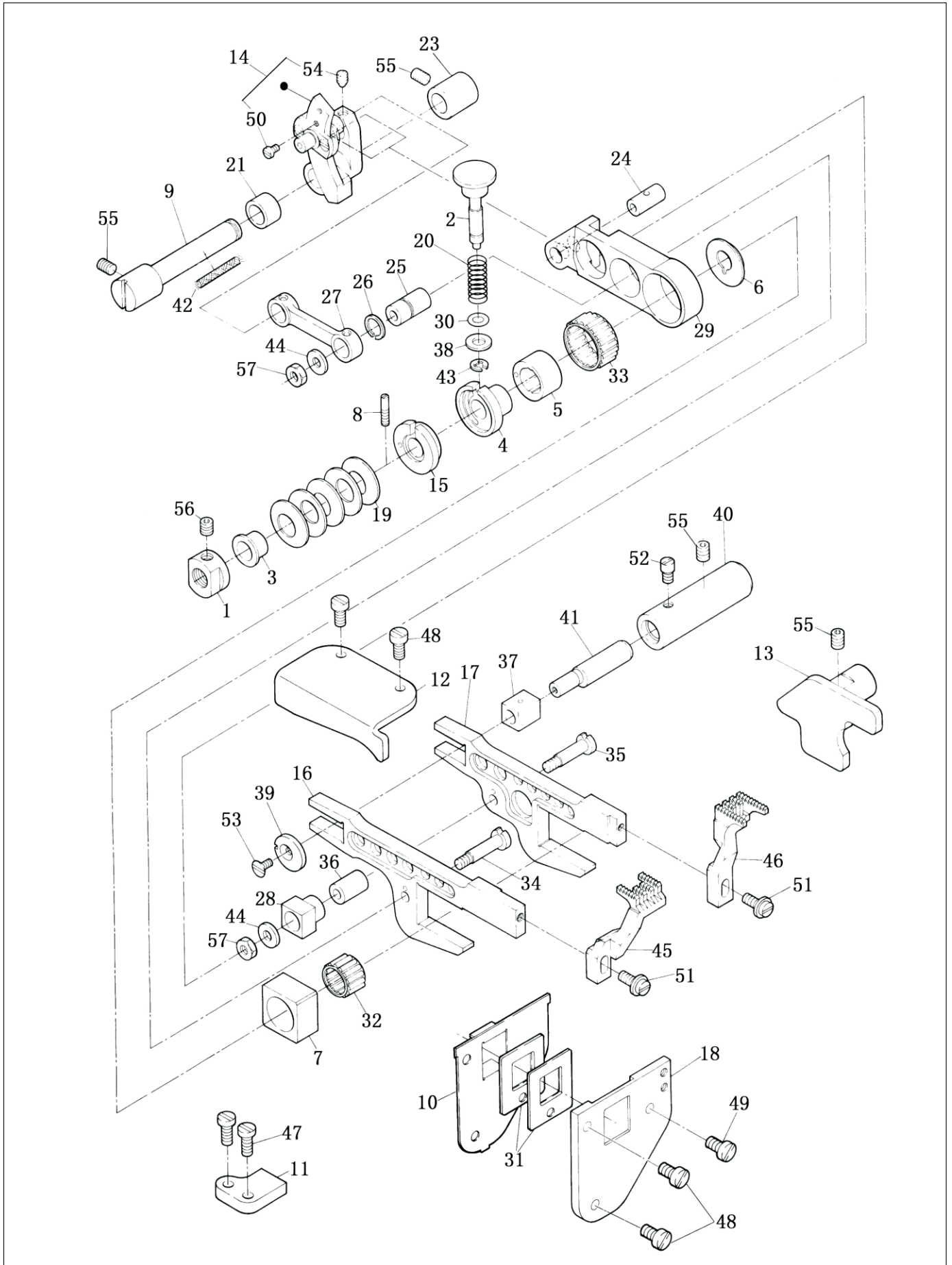

9. 送布部件 MAIN FEED MECHANISM COMPONENTS

序号 NO.	注解 NOTE	图号 REF NO.	名称	DESCRIPTION	数量 AMT
1		301.09-01	凸轮螺母	Cam Nut	1
2		301.09-02	针距按钮	Needle Distance Button	1
3		301.09-03	台阶套	Ladder Bushing	1
4		301.09-04	送布调节凸轮	Feed Dog Regulator Cam	1
5		301.09-05	凸轮	Cam	1
6		301.09-06	送布连杆垫圈	Feed Dog Link Lever Washer	1
7		301.09-07	牙架前滑块	Feed Rack Front Slide Block	1
8		301.09-08	销螺钉	Pin Screw	1
9		301.09-09	差动器轴	Differential Feed Shaft	1
10		301.09-10	垫板	Washer	1
11		301.09-11	左限位板	Left Stopper Plate	1
12		301.09-12	牙架上限位板	Feed Rack Upper Stopper Plate	1
13	#12	343.09-38	牙架右限位板	Feed Rack Right Stopper Plate	1
14		301.09-14	差动器组件	Differential Feed Assembly.	1
		301.09-14-01	差动器组件1	Differential Feed Assembly.	(1)
		301.09-14-02	差动器组件2	Differential Feed Assembly.	(1)
		301.09-14-03	差动器曲柄	Differential Feed Crank	(1)
		12-10300620-01	螺钉	Screw	(2)
15		301.09-15	针距调节套	Needle Distance Regulator Bushing	1
		301.09-16-00	牙架组件		1
16		301.09-16	差动牙架	Differentialfeed Rack	1
17		301.09-17	送布牙架	Feed Dog Rack	1
18	#10	301.09-18	弯针盖	Looper Cover	1
19		23-10310200-09	蝶形弹簧圈	Wave Washer	5
20		301.09-20	针距按钮簧	Needle Distance Button Spring	1
21		301.09-21	差动器隔套	Differential Feed Spacer	1
23		301.09-23	差动器轴套	Differential Feed Bushing	1
24		301.09-24	送布连杆销	Feed Dog Link Lever Pin	1
25		301.09-25	送布连杆销	Feed Dog Link Lever Pin	1
26		26-06810100-09	开口挡圈	Snap Ring	1
27		301.09-27	差动送布连杆	Differential Feed Link Lever	1
28		301.09-28	送布滑块	Feed Dog Slide Block	1
29		301.09-29	送布连杆	Feed Dog Link Lever	1
30		31-04020000-09	O型圈	O-ring	1
31		301.09-31	胶垫片	Rubber Washer	2
32		279.05-27	拍牙滑块轴承	Needle Bearing $\Phi 12 \times \Phi 15 \times 10$	1
33		301.09-33	滚针轴承 $\Phi 17 \times \Phi 21 \times 10$	Needle Bearing $\Phi 17 \times \Phi 21 \times 10$	1
34		301.09-34	连接螺钉	Connection Screw	1
35		301.09-35	送布滑块连接螺钉	Connection Screw	1
36		301.09-36	送布滑块套	Feed Dog Slide Block Bushing	1
37		301.09-37	牙架后滑块	Feed Dog Rack Back Slide Block	1
38		21-05310100-02	垫圈	Washer	1
39		301.09-39	垫圈	Washer	1
40		301.09-40	偏心轴套	Eccentric Bushing	1
41		301.09-41	牙架偏心轴	Eccentric Shaft	1
42		43-10250000-00	油线	Oil Wick	0.02
43		24-04000000-08	开口挡圈	Snap Ring	1
44		21-04615101-01	垫片	Washer	2
45	#21	301.09-45	差动送布牙	Differential Feed Dog	1
	#22	301.09-45(4.8)	差动送布牙(4.8)	Differential Feed Dog	1
		301.09-45(3.2)	差动送布牙	Differential Feed Dog	

9. 送布部件 MAIN FEED MECHANISM COMPONENTS

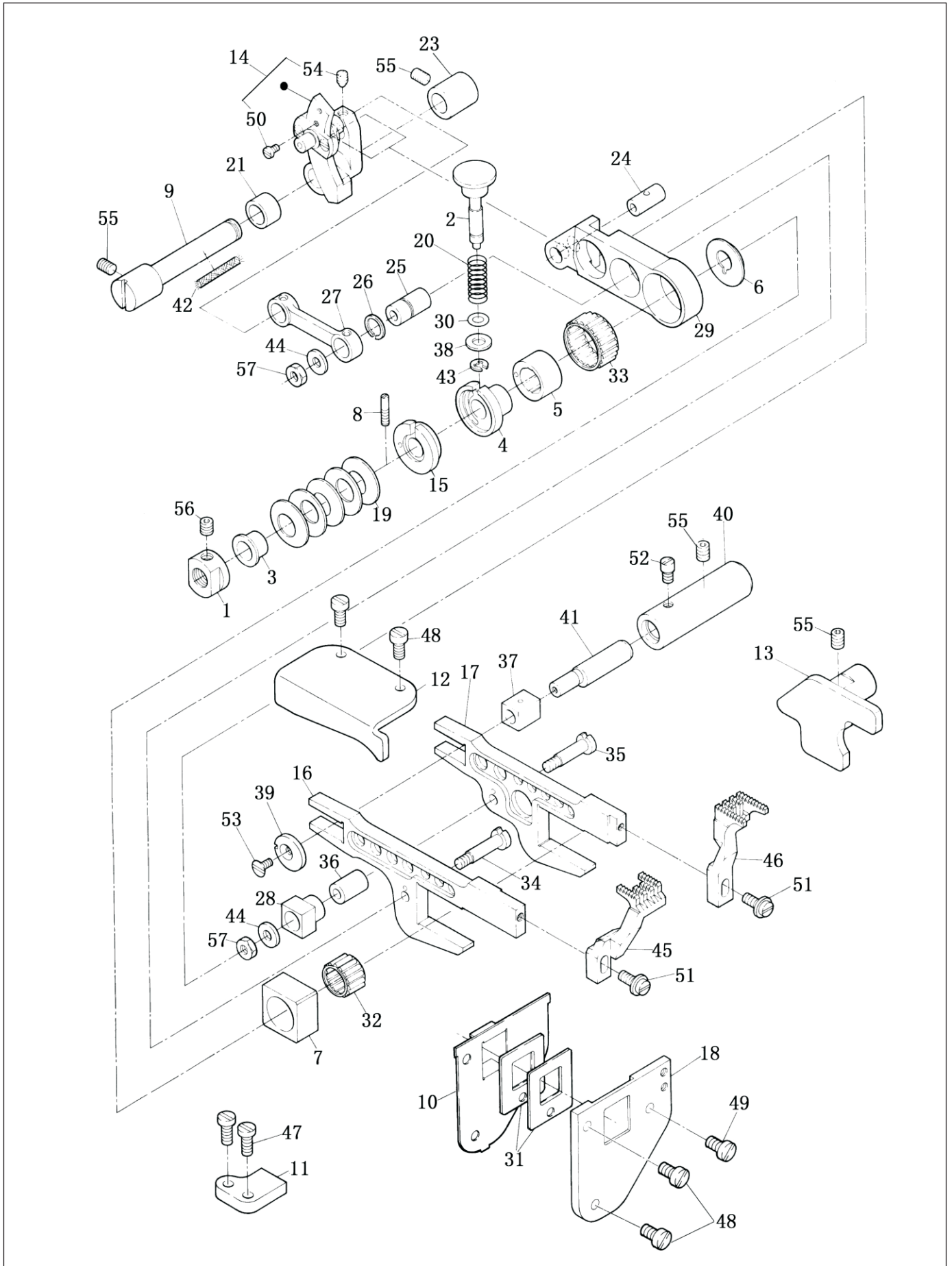

9. 送布部件 MAIN FEED MECHANISM COMPONENTS

序号 NO.	注解 NOTE	图号 REF NO.	名称	DESCRIPTION	数量 AMT
46	#16	312.09-45	差动送布牙	Differential Feed Dog	1
	#21	301.09-46	主动送布牙	Main Feed Dog	1
	#22	301.09-46(4.8)	主动送布牙(4.8)	Main Feed Dog	1
		301.09-46(3.2)	主动送布牙	Main Feed Dog	
47	#16	312.09-46	主动送布牙	Main Feed Dog	1
		12-40401025-01	螺钉	Screw	2
48		12-40400825-01	限位板螺钉	Stopper Plate Screw	4
49		12-70400820-01	螺钉	Screw	1
50		12-40250425-01	差动器螺钉	Differentialfeed Screw	2
51		301.09-51	牙架螺钉	Rack Screw	2
52		11-00110620-01	轴套螺钉	Bushing Screw	1
53		11-10080620-01	螺钉	Screw	1
54		12-80400542-01	螺钉	Screw	1
55		12-80500612-01	螺钉	Screw	4
56		12-80500512-01	螺钉	Screw	1
57		13-60114020-01	螺母	Nut	2

Note:
 #10...For -5不用
 #12...For -21不用
 #16...For -6专用
 #21...For -1、-21、500A-01、-02DN、-7专用
 #22...For -1、500A-01、-7专用

10. 差动部件 DIFFERENTIAL FEED MECHANISM COMPONENTS

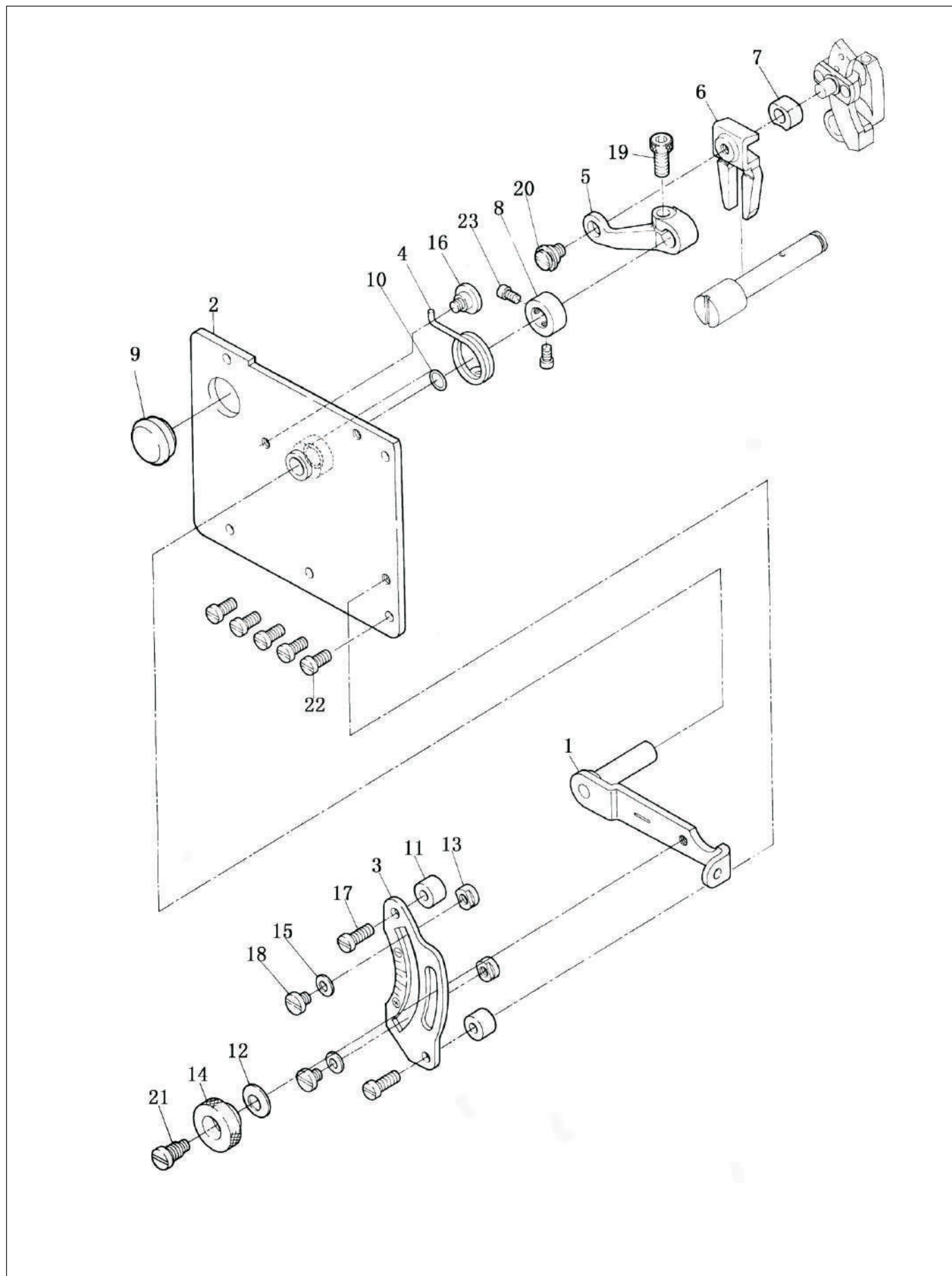

10. 差动部件 DIFFERENTIAL FEED MECHANISM COMPONENTS

序号 NO.	注解 NOTE	图号 REF NO.	名称	DESCRIPTION	数量 AMT
1		301.10-01	调节杆 (组件)	Adjusting Rod Asm.	1
		301.10-01-1	调节杆 (组件)	Adjusting Rod Asm.	(1)
		301.10-01-2	调节杆 (组件)	Adjusting Rod Asm.	(1)
2		301.10-02	差动调节板	Differential Feed Regulating Plate	1
		301.10-02-01	衬套	Bushing	(1)
3		301.10-03	差动调节刻度板	Differential Feed Regulating Graduation Plate	1
4		301.10-04	差动调节复位弹簧	Differential Feed Regulating Return Spring	1
5		301.10-05	差动调节曲柄	Differential Feed Regulating Crank	1
6		301.10-06	差动调节吊板	Differential Feed Regulating Fork Plate	1
7		301.10-07	滑块	Slide Block	1
8		301.10-08	差动板手紧圈	Thrust Ring	1
9		301.10-09	闷头	Plug	1
10		31-08018000-09	O型密封圈	Rubber Ring	1
11		301.10-11	刻度板隔套	Graduation Plate Spacer	2
12		23-06005120-09	蝶形垫圈	Wave Washer	1
13		301.10-13	螺母 (专用)	Nut	2
14		301.10-14	差动调节锁紧螺母	Locknut	1
15		21-04308090-02	平垫圈	Wave Washer	2
16		301.10-16	螺钉	Screw	1
17		11-40111225-01	螺钉	Screw	2
18		11-40110625-01	螺钉	Screw	2
19		12-60501222-01	螺钉	Screw	1
20		301.10-20	螺钉	Screw	1
21		301.10-21	锁紧螺钉	Screw	1
22		12-40400825-01	螺钉	Screw	5
23		11-00090620-01	螺钉	Screw	2

11. 抬压脚部件 PREESSER FOOT LIFTER COMPONENTS

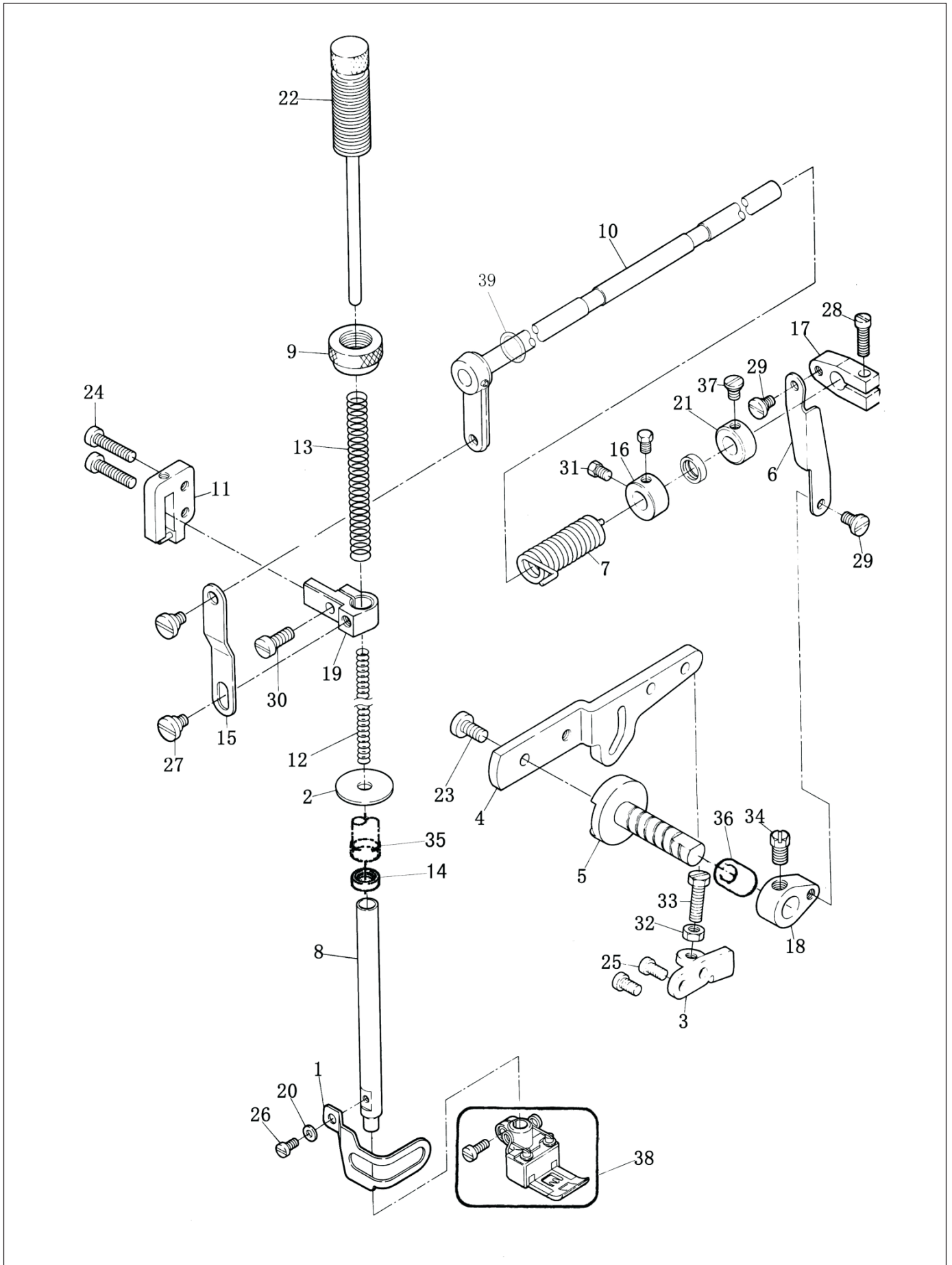

11. 抬压脚部件 PREESSER FOOT LIFTER COMPONENTS

序号 NO.	注解 NOTE	图号 REF NO.	名称	DESCRIPTION	数量 AMT
1	#18、#19	301.11-01	压紧防护罩	Presser Bar Shield	1
2		301.11-02	压紧杆防油罩	Rubber Washer	1
3	#01	301.11-03	限位板	Stopper Plate	1
4		301.11-04	抬压脚拉杆	Presser Foot Lifting Lever	1
5		301.11-05	拉杆座	Lever Base	1
6		301.11-06	抬压脚吊杆	Presser Foot Lifting Steeve	1
7		301.11-07	抬压脚弹簧	Presser Foot Lifting Spring	1
8		301.11-08	压紧杆	Presser Bar	1
9		301.11-09	调压螺母	Adjusting Nut	1
10		301.11-10	抬压脚轴组件	Presser Foot Lifting Shaft	1
		301.11-10-01	抬压脚轴	Presser Foot Lifting Shaft	(1)
		301.11-10-02	抬压脚轴曲柄	Presser Foot Lifting Shaft Crank	(1)
11		301.11-11	压杆导架座	Presser Bar Guide Bracket Base	1
12		301.11-12	调压内弹簧	Presser Regulating Inner Spring	1
13		301.11-13	调压弹簧	Presser Regulating Spring	1
14		32-08440150-09	骨架油封	O-ring	1
15		301.11-15	抬压脚吊板	Presser Foot Lifting Steeve	1
16		301.11-16	抬压脚轴紧圈	Thrust Ring	1
17		301.11-17	抬压脚曲柄	Presser Foot Lifting Crank	1
18		301.11-18	吊杆曲柄	Steeve Crank	1
19		301.11-19	压杆导架	Presser Bar Guide Bracket	1
20	#04	21-03208070-02	垫圈	Washer	1
21		301.11-21	限位紧圈	Thrust Ring	1
22		301.11-22	调压螺钉 (组件)	Adjusting Screw	1
		301.11-22-01	调压螺钉轴	Adjusting Screw Shaft	(1)
		301.11-22-02	调压螺钉	Adjusting Screw	(1)
23		12-60501022-01	螺钉	Screw	1
24		12-40402025-01	导架座螺钉	Bracket Base Screw	2
25	#01	12-40400825-01	螺钉	Screw	2
26	#04	12-40300625-01	螺钉	Screw	1
27		301.11-27	螺钉	Screw	2
28		11-70111420-01	螺钉	Screw	1
29		301.11-29	螺钉	Screw	2
30		11-40111225-01	螺钉	Screw	1
31		11-00110620-01	螺钉	Screw	2
32	#01	14-60504020-01	螺母	Nut	1
33	#01	12-90502520-01	螺钉	Screw	1
34		11-00160920-01	螺钉	Screw	1
35		343.11-12	压紧杆套	Presser Bar Bushing	1
36		301.11-36	拉杆座套	Lever Base Bushing	1
37		11-00110620-01	螺钉	Screw	1
38	#23	301.11-38	压脚 (组件)	Presser Foot	1
	#22	301.11-38(6.4)	压脚 (组件) (6.4)	Presser Foot	1
	#22	301.11-38(4.8)	压脚 (组件) (4.8)	Presser Foot	1
		301.11-38(3.2)	压脚	Presser Foot	1
	#16	312.11-38	压脚 (组件)	Presser Foot	1
39		31-07524000-09	O型圈	O-ring	1

Note:
 #01...For -7不用 #04...For -02HY不用
 #06...For -5、-02HY、-7不用
 #18...For -5、-21不用 #19...For -4不用
 #22...For -1、500A-01、-7专用
 #23...For -1、500A-01、-02DN、-7专用

12. 绷针部件 STRETCH NEEDLE COMPONENTS

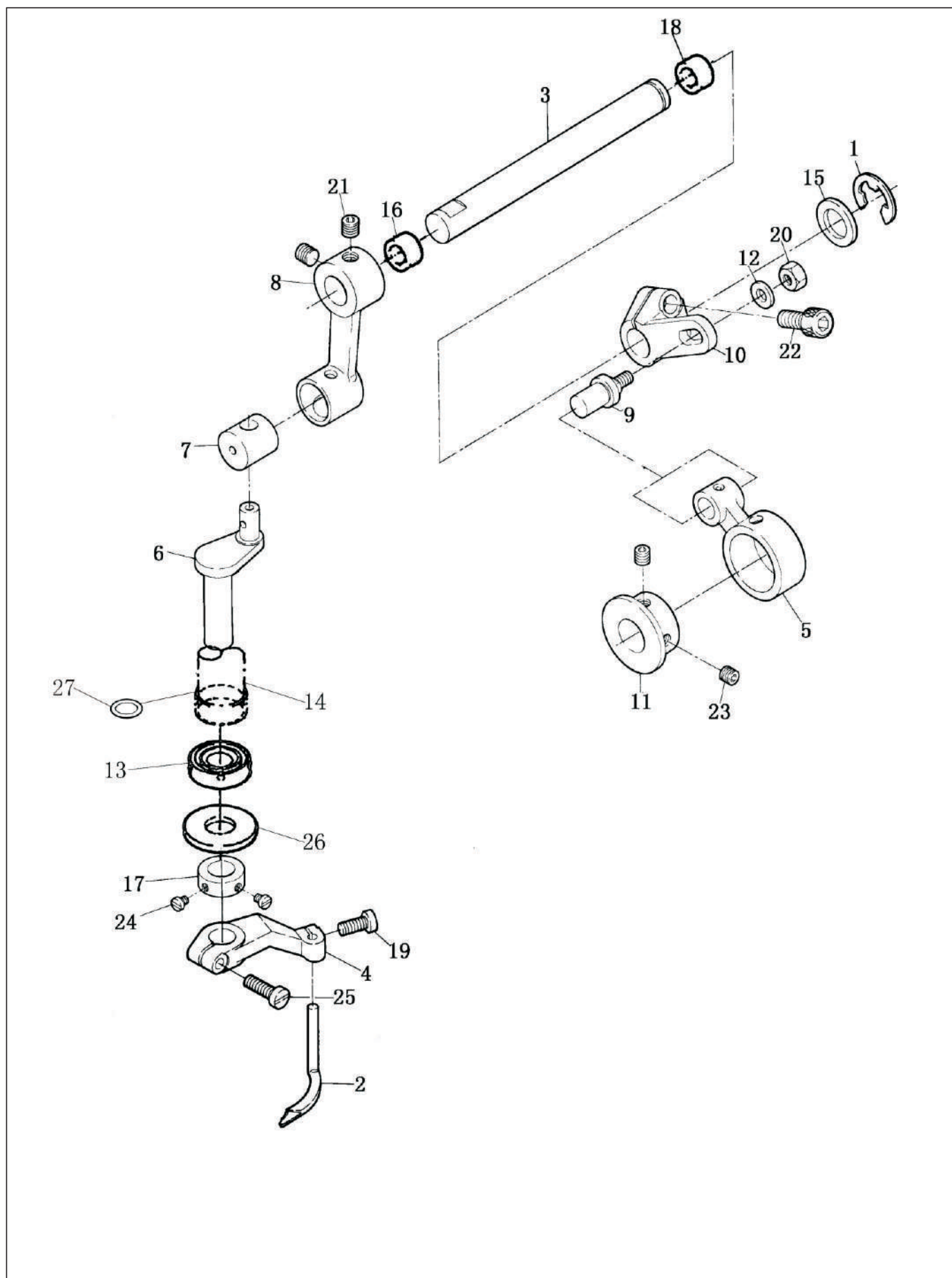

12. 绷针部件 STRETCH NEEDLE COMPONENTS

序号 NO.	注解 NOTE	图号 REF NO.	名称	DESCRIPTION	数量 AMT
1	#24	24-10000000-09	开口挡圈	Snap Ring	1
2	#24	301.12-02	绷针	Stretch Tight Needle	1
3	#24	301.12-03	绷针横轴	Stretch Tight Needle Crossing Shaft	1
4	#24	301.12-04	绷针下摆杆	Lower Oscillating Bar	1
5	#24	301.12-05	绷针连杆	Stretch Tight Needle Link Lever	1
6	#24	301.12-06	绷针曲柄	Stretch Tight Needle Crank	1
7	#12	301.12-07	绷针连接柱	Stretch Tight Needle Connecting Pole	1
8	#24	301.12-08	绷针上摆杆	Upper Oscillating Bar	1
9	#24	301.12-09	摆杆螺钉	Oscillating Bar Screw	1
10	#24	301.12-10	绷针调节摆杆	Regulate Oscillating Bar	1
11	#24	301.12-11	绷针凸轮	Stretch Tight Needle Cam	1
12	#24	21-05212121-03	垫圈	Washer	1
13	#04、#20	32-09440190-09	骨架 油封	O-ring	1
14	#20	301.12-14	绷针竖套	Stretch Tight Needle Upright Bushing	1
15	#24	21-12114152-03	垫圈	Washer	1
16	#24	301.12-16	绷针左套	Stretch Tight Needle Left Bushing	1
17	#24	301.12-17	绷针紧圈	Thrust Ring	1
18	#24	301.12-16	绷针右套	Stretch Tight Needle Right Bushing	1
19	#24	12-40401025-01	螺钉	Screw	1
20	#24	14-60504020-01	螺母	Nut	1
21	#24	12-85600512-01	螺钉	Screw	2
22	#24	12-65601422-01	螺钉	Screw	1
23	#24	12-80500512-01	螺钉	Screw	2
24	#24	11-40080425-01	螺钉	Screw	2
25	#24	12-40401425-01	螺钉	Screw	1
26	#24	21-10220232-03	垫圈	Washer	1
27	#24	31-10020000-09	O型圈	Rubber Ring	1

Note:
#04...For -02HY不用
#20...For -4、-21不用
#24...For -4、-02HY不用

13. 过线器部件 THREAD GUIDE MECHANISM COMPONENTS

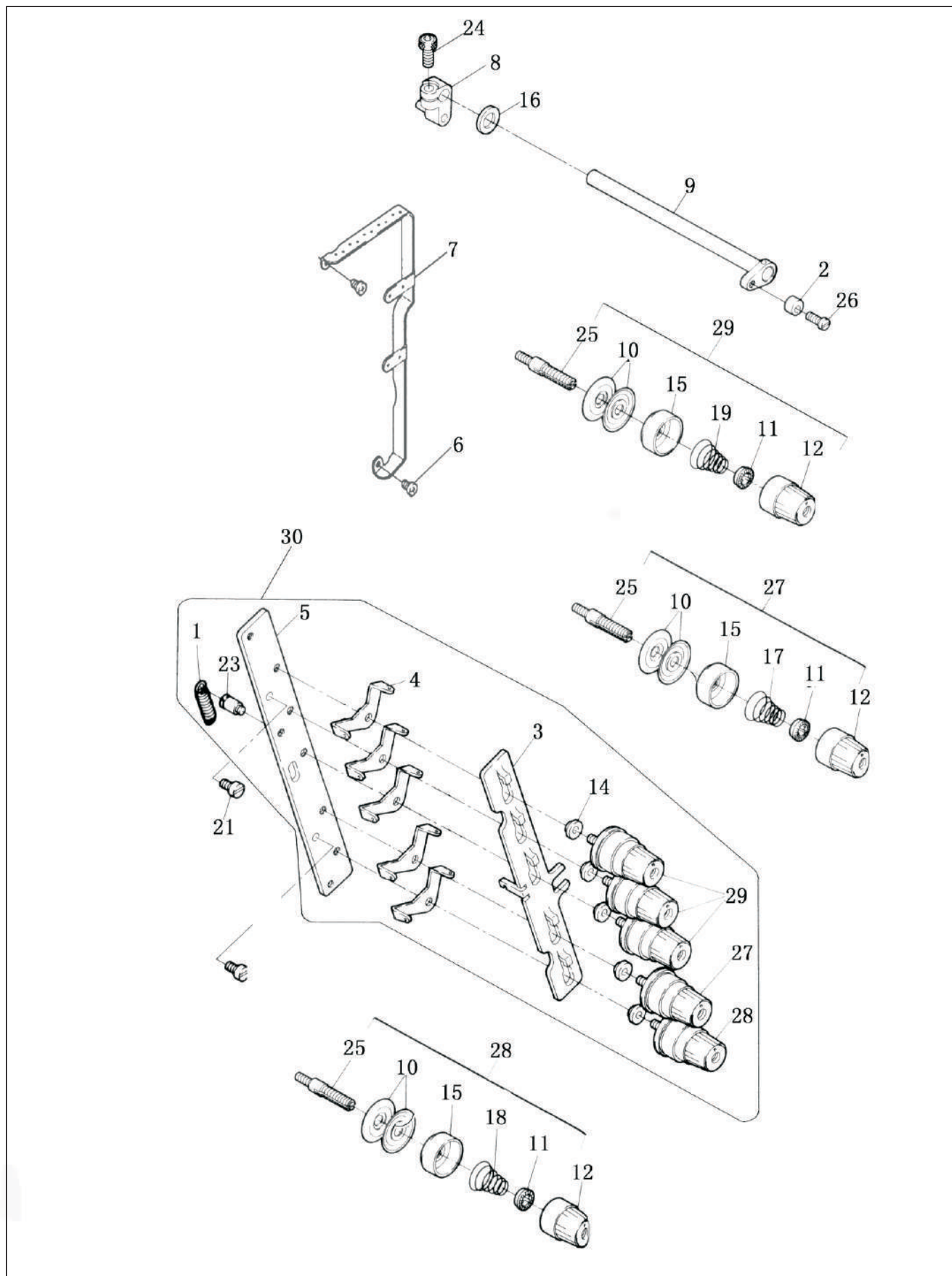

13. 过线器部件 THREAD GUIDE MECHANISM COMPONENTS

序号 NO.	注解 NOTE	图号 REF NO.	名称	DESCRIPTION	数量 AMT
1		301.13-01	挺线板拉簧	Spring	(1)
2	#01	301.13-02	隔套	Spacer	1
3	#25	301.13-03	过线座	Thread Eyelet Base	(1)
	#16	312.13-03	过线座	Thread Eyelet Base	(1)
4		301.13-04	压线过线板2	Thread Guide Plate2	(5)
5	#12、#25	301.13-05	挺线板	Thread Eyelet Base	(1)
	#16	312.13-05	挺线板	Thread Eyelet Base	(1)
6	#12	12-40400525-01	螺钉	Screw	2
7	#12、#25	340.13-07	过线架	Thread Eyelet Stand	1
	#16	312.13-07	过线架	Thread Eyelet Stand	1
8	#01	301.13-08	挺线杆曲柄	Thread Eyelet Base Shaft Crank	1
9	#01	301.13-09	挺线杆(组件)	Thread Eyelet Base Shaft	1
	#01	301.13-09-01	挺线杆轴	Thread Eyelet Base Shaft	(1)
	#01	301.13-09-02	挺线杆曲柄	Thread Eyelet Base Crank	(1)
10		301.13-10	夹线板	Thread Tension Plate	(10)
11		301.13-11	夹线防松圈	Thread Tension Ring	(5)
12		301.13-12	夹线螺母	Thread Tension Nut	(5)
14		301.13-14	垫圈	Washer	(5)
15		301.13-15	夹线座	Thread Tension Base	(5)
16		21-08220151-01	垫圈	Washer	1
17		301.13-17	夹线簧	Thread Tension Spring	(1)
18		301.13-18	夹线簧	Thread Tension Spring	(1)
19		301.13-19	夹线簧	Thread Tension Spring	(3)
21		12-40400825-01	螺钉	Washer	2
23		301.13-23	挺线板螺钉	Screw	(1)
24	#01	12-60501222-01	螺钉	Screw	1
25		301.13-25	夹线螺钉	Thread Tension Screw Stud	(5)
26	#01	11-40111225-01	螺钉	Screw	1
27		301.13-27	夹线器组件B	Thread Tension Spring Arm B	(1)
28		301.13-28	夹线器组件C	Thread Tension Spring Arm C	(1)
29		301.13-29	夹线器组件A	Thread Tension Spring Arm A	(3)
30		343.13-10	夹线器大组件	Thread Tension Spring Arm.	1

Note:
 #01...For -7不用
 #12...For -21不用
 #16...For -6专用
 #25...For -6不用

14. 过线部件 THREAD GUIDE COMPONENTS

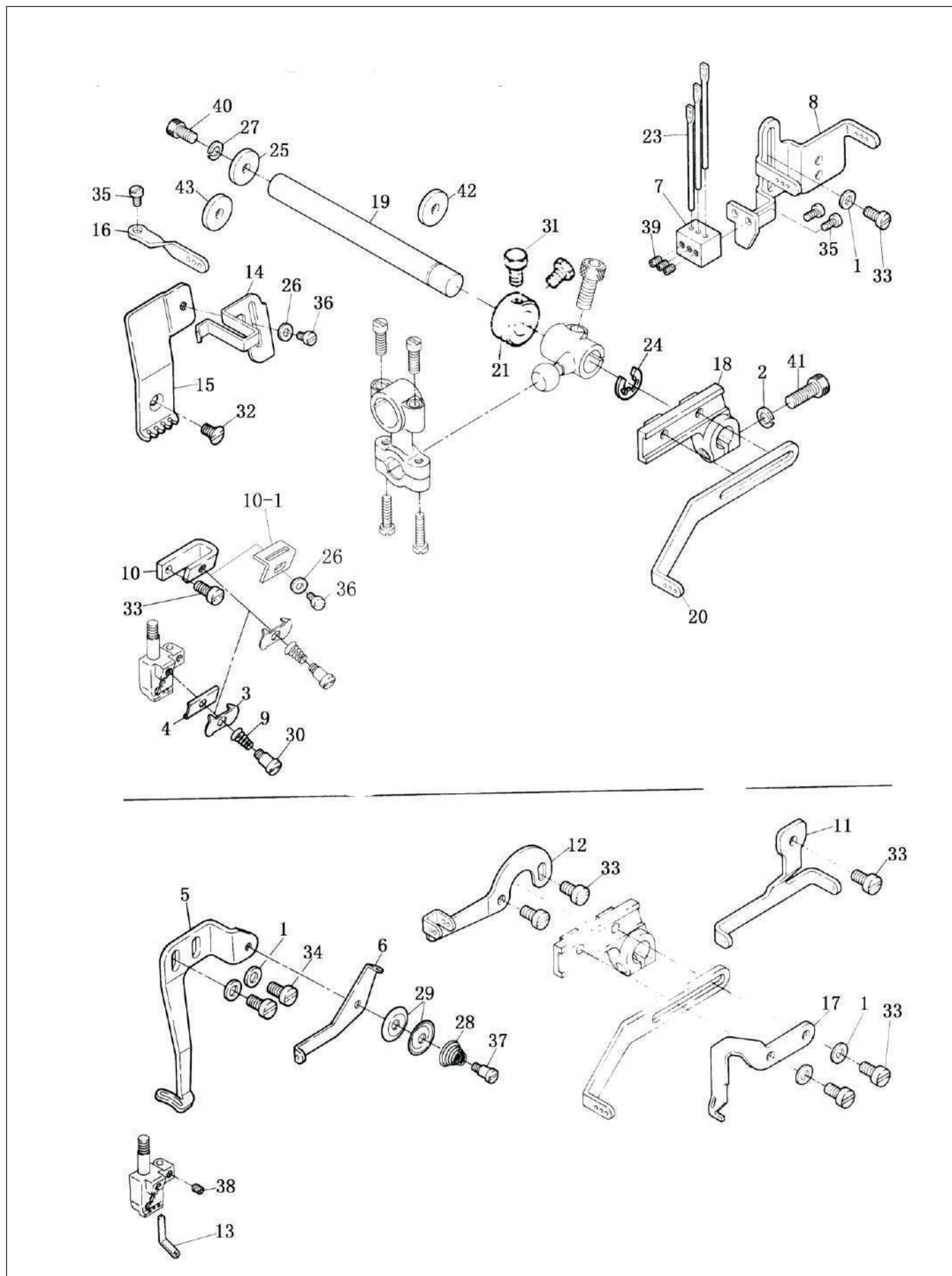

14. 过线部件 THREAD GUIDE COMPONENTS

序号 NO.	注解 NOTE	图号 REF NO.	名称	DESCRIPTION	数量 AMT
1	#04	21-04308090-02	垫圈	Washer	5
2	#04	22-05000000-08	垫圈	Washer	1
3		301.14-03	针轧过线压板	Thread Guide Pressing Plate	1
4		301.14-04	针轧过线板	Thread Guide Plate	1
5	#12、#24	301.14-05	绷线过线下过线板	Lower Thread Guide Plate	1
6	#24	301.14-06	绷线过线板	Thread Guide Plate	1
7	#25	301.14-07	硅油过线座	Silicone Thread Guide Base	1
	#16	312.14-07	硅油过线座	Silicone Thread Guide Base	1
8	#25	301.14-08	硅油过线座	Silicone Thread Guide Base	1
	#16	312.14-08	硅油过线座	Silicone Thread Guide Base	1
9		301.14-09	针轧过线簧	Thread Eyelet Spring	1
10		301.14-10	小过线座	Thread Guide Base (small)	1
		301.14-10-01	挡线板	Block The Line Plank	1
11	#24	301.14-11	绷线上导线板	Upper Thread Guide Plate	1
12	#19	301.14-12	张线杆	Thread Eyelet Guide Lever	1
13	#24	301.14-13	针轧右过线杆	Thread Eyelet Right Bar	1
14		301.14-14	挑线防护罩	Thread Take-up Shield	1
15		301.14-15	挑线防护罩座	Thread Take-up Shield Base	1
16		301.14-16	针杆上过线	Needle Bar Top Thread Guide	1
17		301.14-17	上叉挑线杆	Thread Take-up Lever	1
18		301.14-18	挑线杆座	Thread Take-up Lever Base	1
19		301.14-19	挑线杆轴	Thread Take-up Lever Shaft	1
20	#25	301.14-20	挑线杆	Thread Take-up Lever	1
	#16	312.14-20	挑线杆	Thread Take-up Lever	1
21		301.14-21	紧圈	Thrust Ring	1
23		301.14-23	挑线钉	Thread Eyelet Guided Nail	3
24		24-07000000-09	开口挡圈	Snap Ring	1
25		21-04520141-01	垫圈	Washer	1
26		21-03208070-02	垫圈	Washer	2
27		22-04000000-08	止退圈	Stopper Ring	1
28	#24	301.14-28	压线簧	Presser Spring	1
29	#24	279.04-58	过线板	Presser Plate	2
30		301.14-30	针轧过线螺钉	Screw	1
31		11-00110620-01	螺钉	Screw	2
32		12-10400820-01	螺钉	Screw	1
33	#04	12-40400825-01	螺钉	Screw	7
34	#12、#24	12-40400825-01	螺钉	Screw	2
35		12-40300625-01	螺钉	Screw	3
36		12-60300420-01	螺钉	Screw	2
37	#12、#24	301.14-37	夹线螺钉	Screw	1
38	#19	12-80300312-01	螺钉	Screw	1
39		12-80300412-01	螺钉	Screw	3
40		12-60400822-01	挑线杆轴螺钉	Thread Take-up Lever Shaft Screw	1
41		12-60501622-01	螺钉	Screw	1
42		301.08-20	挑线杆轴前套	Thread Take-up Lever Shaft Front Bushing	1
43		301.14-43	挑线杆轴后套	Thread Take-up Lever Shaft Back Bushing	1

Note:
 #04...For -02HY不用
 #12...For -21不用
 #16...For -6专用
 #19...For -4不用
 #24...For -4、-02HY不用
 #25...For -6不用

15. 下过线器部件 LOWER THREAD TENSION COMPONENTS

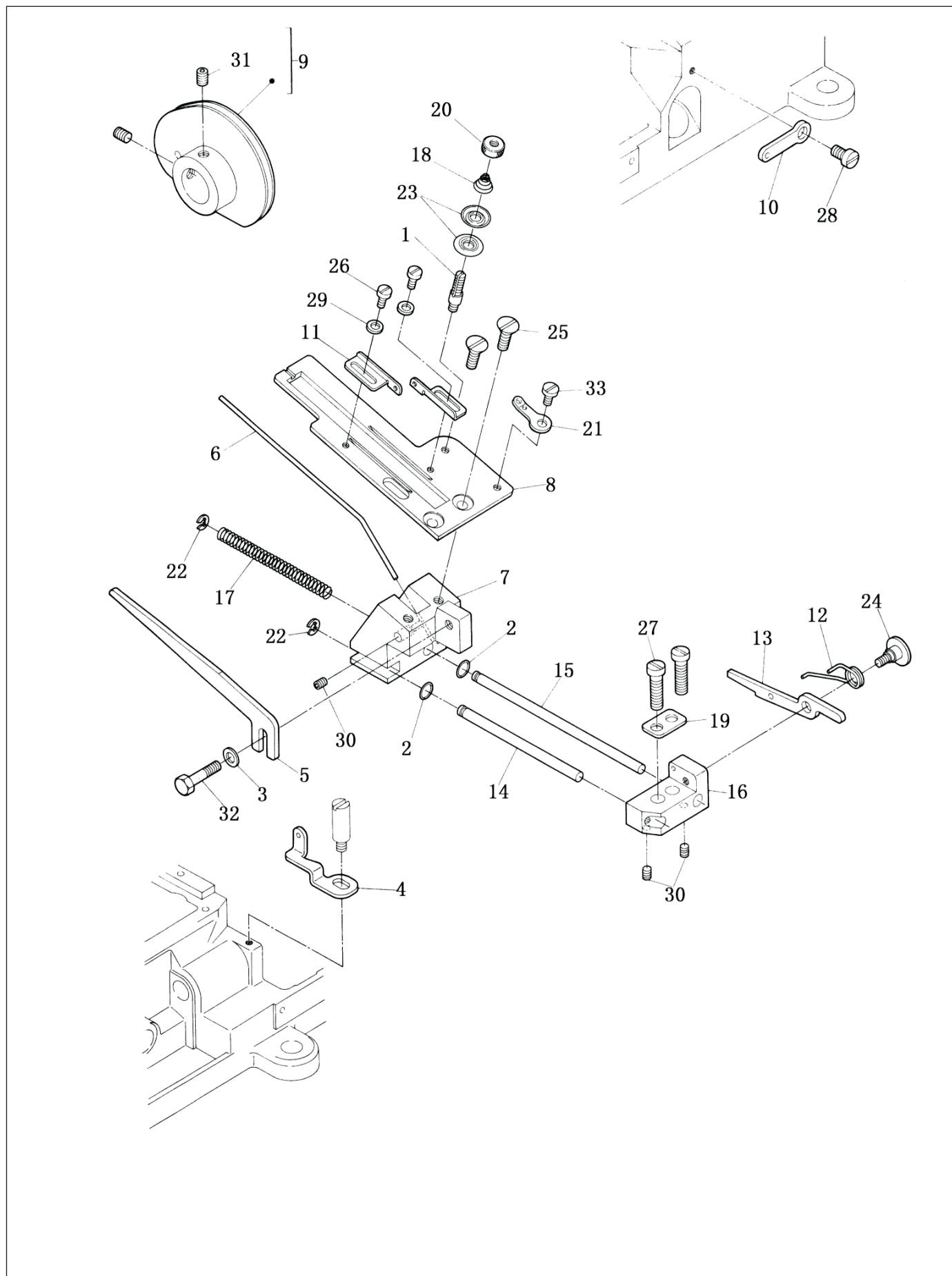

15. 下过线器部件 LOWER THREAD TENSION COMPONENTS

序号 NO.	注解 NOTE	图号 REF NO.	名称	DESCRIPTION	数量 AMT
	#26	301.15-00	打线器组件		1
1	#26	209.19-11	压线板螺钉	Screw	(1)
2	#26	31-05020000-09	O型垫圈	O-ring	(2)
3	#26	21-04308090-02	垫圈	Washer	(1)
4		301.15-04	过线板	Thread Guide Plate	1
5	#26	301.15-05	下过线压板	Lower Thread Guide Presser Plate	(1)
6	#26	301.15-06	下过线杆	Lower Thread Eyelet Bar	(1)
7	#26	301.15-07	下过线架	Lower Thread Guide Frame	(1)
8	#26	301.15-08	下过线板	Lower Thread Guide Plate	(1)
9	#26	301.15-09	凸轮 (组件)	Cam Asm.	1
	#26	301.15-09-01	绕线凸轮	Round The Line Cam	(1)
	#26	301.15-09-02	凸轮衬套	Cam Bushing	(1)
	#26	301.15-09-03	打线凸轮垫圈	Washer	(1)
10	#19	301.15-10	过线板	Thread Guide Plate	1
11	#19、#26	301.15-11	下过线板	Lower Thread Guide Plate	(2)
12	#26	301.15-12	下过线勾	Lower Thread Finger	(1)
13	#26	301.15-13	扳手	Handle	(1)
14	#26	301.15-14	下线短导杆	Short Thread Leader Rod	(1)
15	#26	301.15-15	下过线导杆	Thread Leader Rod	(1)
16	#26	301.15-16	下过线座	Lower Thread Guide Seating	(1)
17	#26	301.15-17	压簧	Press Spring	(1)
18	#26	209.19-13	绷线簧	Spring	(1)
19	#26	301.15-19	下过线垫片	Washer	1
20	#26	209.19-14	螺母 (夹线板专用)	Nut	(1套)
21	#26	301.15-21	下过线板	Lower Thread Guide Plate	(1)
22	#26	301.15-22	开口挡圈	Snap Ring	(2)
23	#26	209.19-12	绷线小压板	Presser Plate	(2)
24	#26	301.15-24	螺钉	Screw	(1)
25	#26	12-10400820-01	螺钉	Screw	(2)
26	#26	12-60250420-01	螺钉	Screw	(2)
27	#26	12-40401625-01	螺钉	Screw	2
28		12-40400625-01	螺钉	Screw	1
29	#26	21-02705060-01	垫圈	Washer	(2)
30	#26	12-80300312-01	螺钉	Screw	(3)
31	#26	12-80500512-01	螺钉	Screw	2
32	#26	12-90400620-01	螺钉外六角	Screw	(1)
33	#26	12-60300420-01	螺钉	Screw	(1)

Note:
#19...For -4不用
#26...For 500-01不用

16. 供油部件 LUBRICATION MECHANISM COMPONENTS

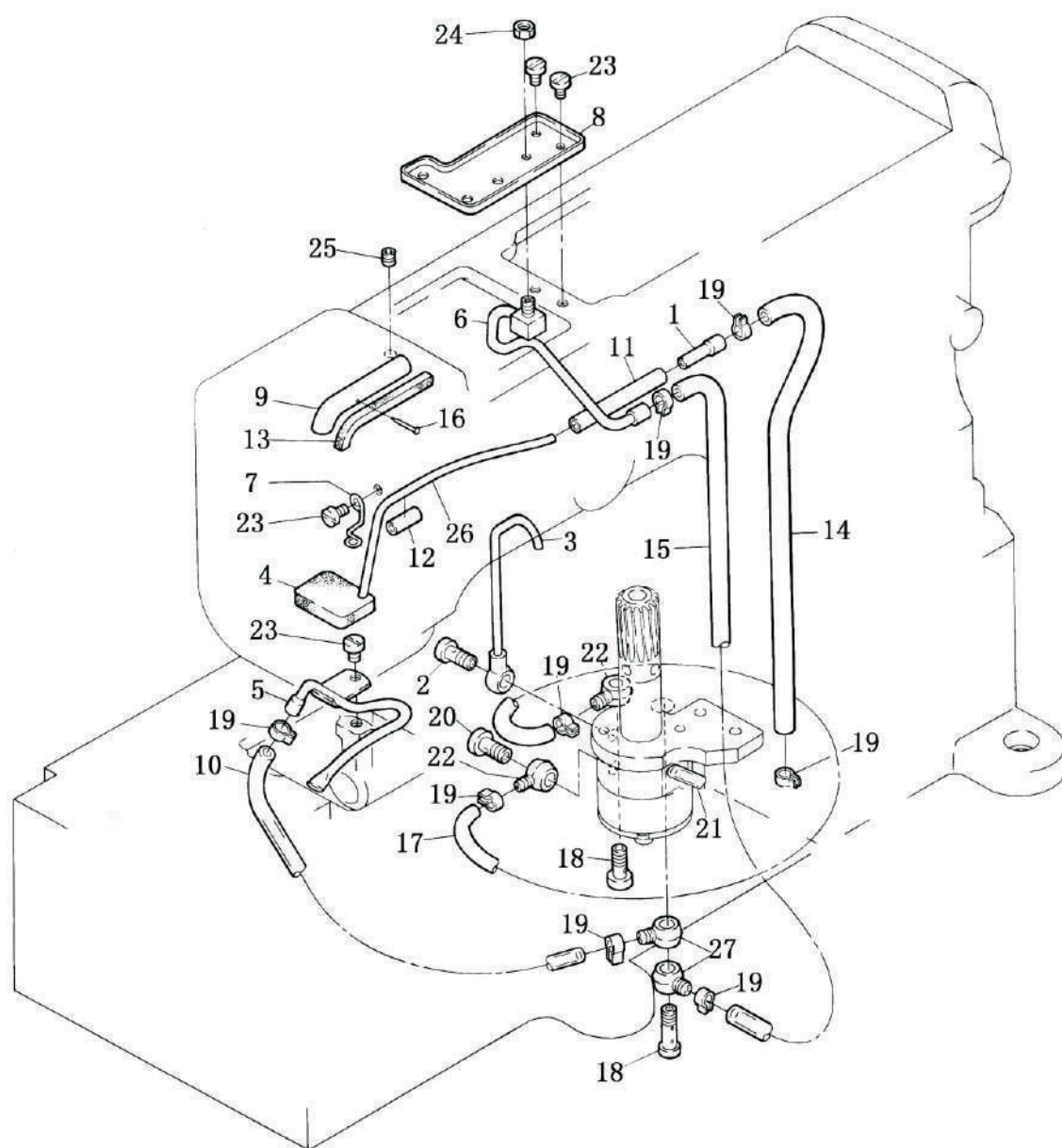

16. 供油部件 LUBRICATION MECHANISM COMPONENTS

序号 NO.	注解 NOTE	图号 REF NO.	名称	DESCRIPTION	数量 AMT
1		301.16-01	管接头	Terminal	1
2		301.16-02	螺钉小双通油接头	Screw With Small Double Holes	1
3		301.16-03	油管组件	Oil Tube Complete	1
4		301.16-04	羊毛毡	Wool Felt	1
5		301.16-05	下油管组件	Lower Oil Tube Complete	1
6		301.16-06	油管组件	Oil Tube Complete	1
7		301.16-07	油管定位勾	Oil Tube Holder	1
8	#04	301.16-08	上油盘	Upper Oil Pan	1
9		301.16-09	油管	Oil Tube	1
10		42-07005000-00	油管5×7×260	Oil Tube 5×7×260	0.26
11		301.16-11	油管	Oil Tube	1
12		42-05003000-00	小油管3×5×40	Small Oil Tube 3×5×40	0.04
13		43-10300000-00	油线	Oil Wick	1
14		42-07005000-00	油管5×7×310	Oil Tube 5×7×310	0.31
15		42-07005000-00	油管5×7×400	Oil Tube 5×7×400	0.4
16		301.16-16	油线钉	Oil Wick Nail	1
17		42-07005000-00	油管5×7×190	Oil Tube 5×7×190	0.19
18		301.16-18	螺钉双通油接头	Screw With Double Holes	2
19		301.16-19	夹头	Collet	2
20		301.16-20	螺钉单通油螺钉	Screw With Single Hole	1
21		301.16-20-01	管接头	Terminal	1
22		301.16-21	管接头(单)	Terminal (Single Hole)	2
23		12-40400625-01	螺钉	Screw	4
24		14-60403020-01	螺母	Nut	1
25		12-80500512-01	螺钉	Screw	1
26		301.16-25	油管	Oil Tube	1
27		301.16-26	管接头(双)	Terminal	1
28		301.16-19-02	夹头(中)		6

Note:
#04...For -02HY不用

17. 油泵部件 PUMP COMPONENTS

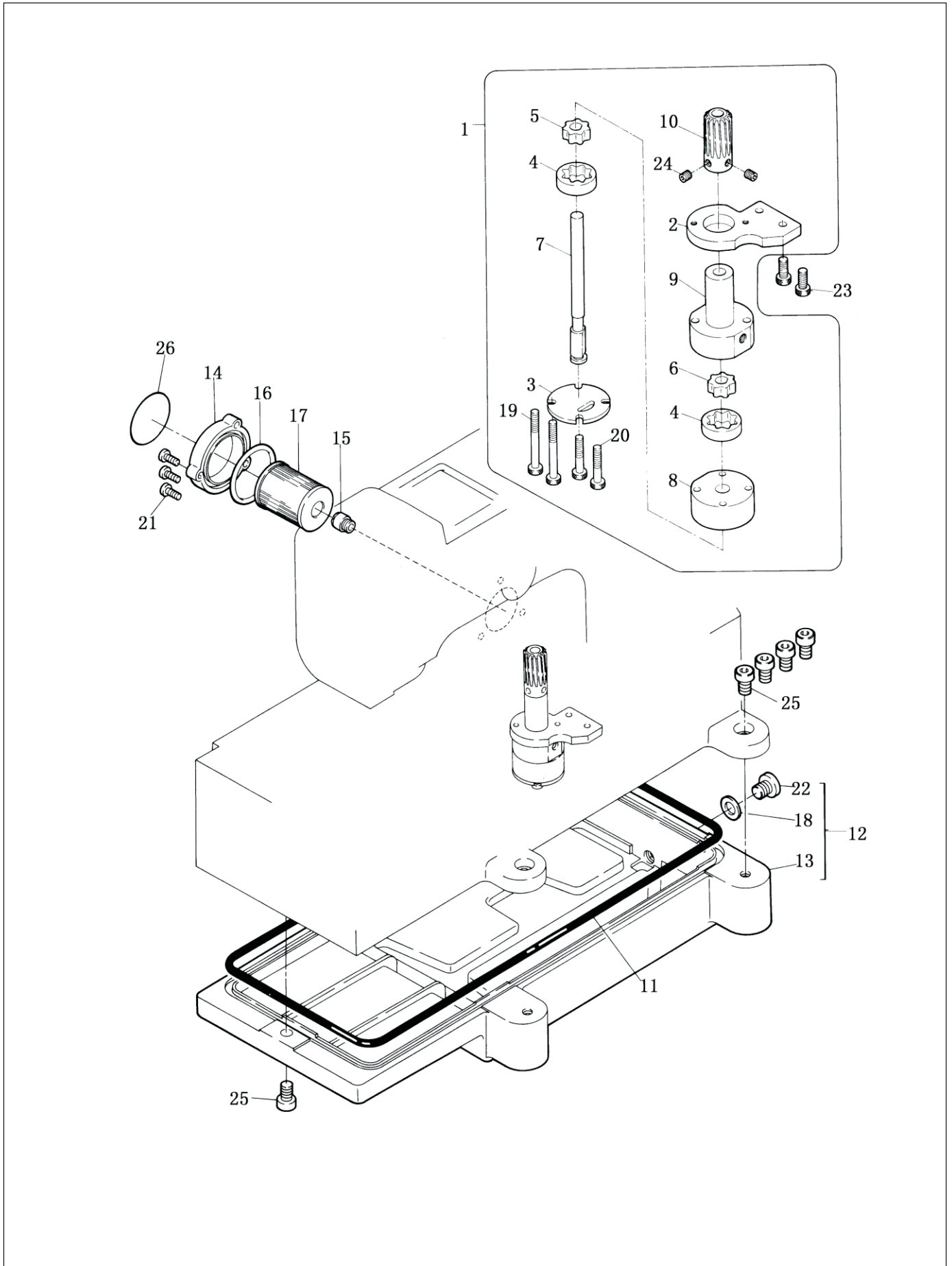

17. 油泵部件 PUMP COMPONENTS

序号 NO.	注解 NOTE	图号 REF NO.	名称	DESCRIPTION	数量 AMT
1		301.17-01	(油泵组件)	Pump Complete	1
2		301.17-02	油泵连接板	Fixing Plate	(1)
3		301.17-03	油泵端盖(底板)	Motherboard	(1)
4		301.17-04	内齿轮	Inner Gear Wheel	(2)
5		301.17-05	上齿轮	Gear Wheel (upper)	(1)
6		301.17-06	下齿轮	Gear Wheel (lower)	(1)
7		301.17-07	油示轴	Shaft	(1)
8		301.17-08	油泵壳体	Pump Body	(1)
9		301.17-09	上油泵体	Upper Pump Body	(1)
10		301.17-10	油泵蜗轮	Small Gear Wheel	(1)
11		343.17-08	油盘防油垫	Oil Protecting Gasket	1
12		301.17-12	油盘组件	Oil Pan Asm.	1
13		301.17-13	油盘	Oil Pan	1
14		301.17-14	滤油器盖	Pump Filter Cover	1
15		301.17-15	滤油器螺钉	Pump Filter Screw	1
16		31-39035000-09	O型圈	O-ring	1
17		279.08-23	纸质滤油器	Pump Filter	1
18		301.17-18	密封垫	Oil Protecting Gasket	1
19		301.17-20	螺钉	Screw	(2)
20		301.17-21	螺钉	Screw	(2)
21		12-40401225-01	螺钉	Screw	3
22		301.17-23	油盘螺钉	Oil Pan Screw	1
23		12-60501222-01	螺钉	Screw	2
24		12-80500512-01	螺钉	Screw	(2)
25		12-60802022-01	螺钉	Screw	5
26		44-00000008-00	商标	Brand	1

18. 机针冷却器部件 NEEDLE COOLING MECHANISM COMPONENTS

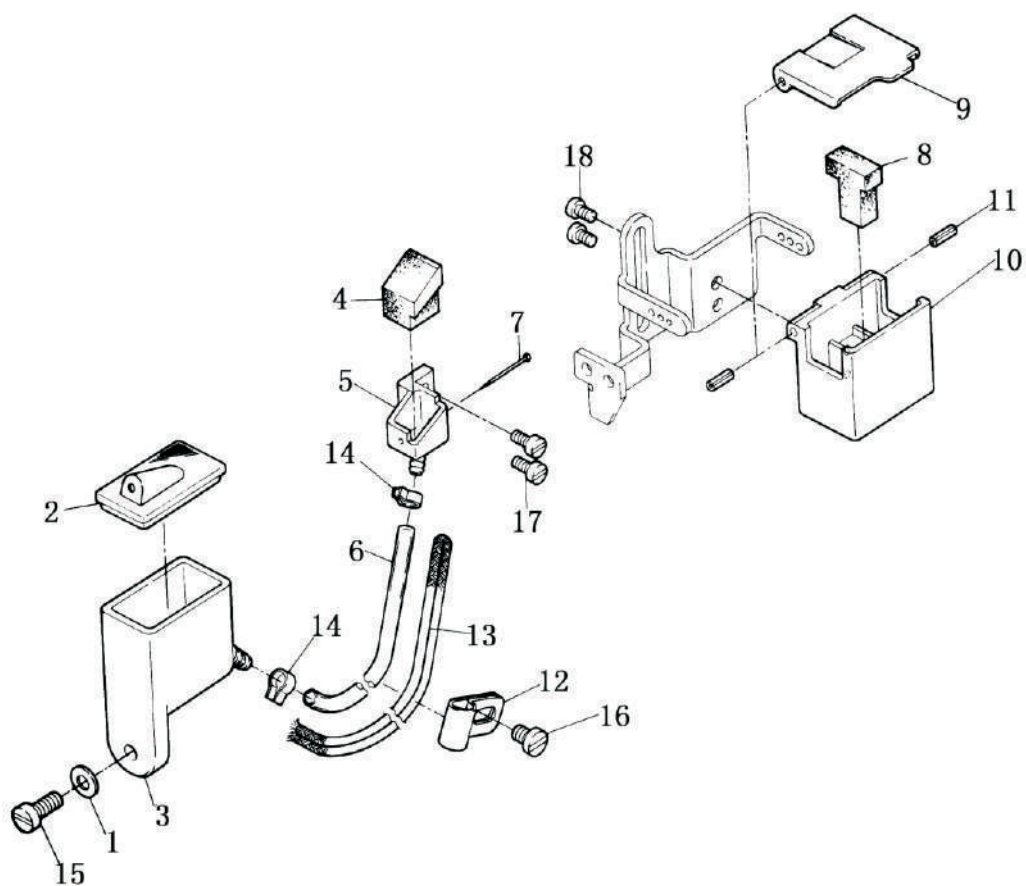

18. 机针冷却器部件 NEEDLE COOLING MECHANISM COMPONENTS

序号 NO.	注解 NOTE	图号 REF NO.	名称	DESCRIPTION	数量 AMT
1	#19	21-04308090-02	垫圈	Washer	1
2	#19	301.18-02	硅油储盒盖	Silicone Oil Reservoir Cover	1
3	#19	301.18-03	硅油储盒	Silicone Oil Reservoir	1
4	#19	301.18-04	硅油盒油毡	Silicone Oil Reservoir Felt	1
5	#19	301.18-05	硅油盒壳体	Silicone Oil Reservoir Body	1
6	#19	42-07005000-00	硅油输油管	Silicone Oil Effluent	0.135
7	#19	279.09-20	大头针	Pin	1
8		301.18-08	上硅油毡	Silicone Oil Felt (upper)	1
9		301.18-09	上硅油盖	Silicone Oil Cover (upper)	1
10		301.18-10	上硅油盒	Silicone Oil Case (upper)	1
11		41-20200500-00	开口弹簧销 $\phi 2 \times 5$	Elastic Pin $\phi 2 \times 5$	2
12	#19	301.18-12	油线压板	Oil Wick Press Plate	1
13	#19	43-10250000-00	油线	Oil Wick	0.27
14	#19	301.16-19-01	弹簧管夹头(小)	Spring Tube Collet	2
15	#19	12-40401025-01	螺钉	Screw	1
16	#19	12-40400625-01	螺钉	Screw	1
17	#19	12-40300625-01	螺钉	Screw	2
18		11-40090525-01	螺钉	Screw	2

Note:
#19...For -4不用

19. 线架部件 THREAD STAND COMPONENT

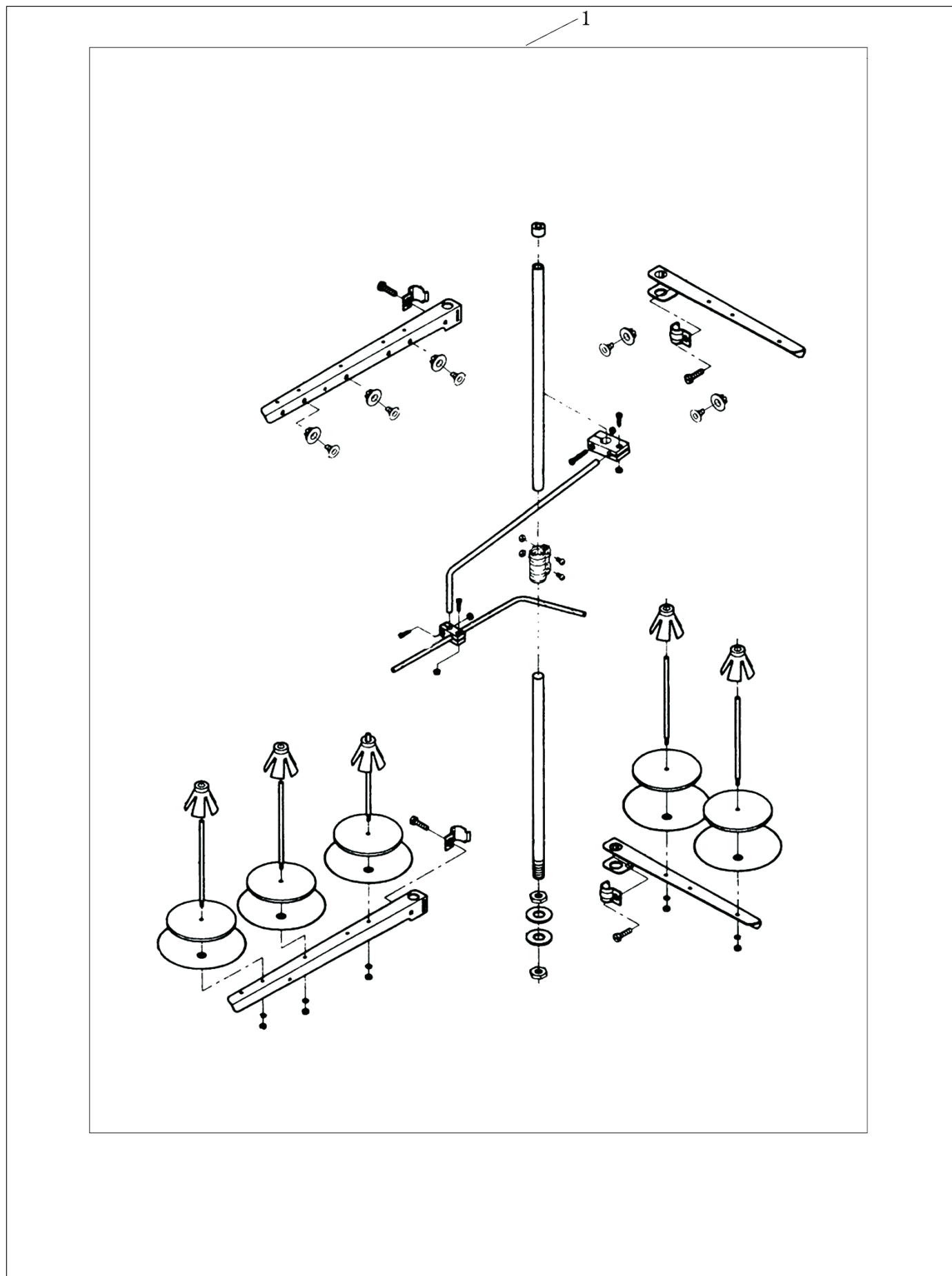

19. 线架部件 THREAD STAND COMPONENT

序号 NO.	注解 NOTE	图号 REF NO.	名称	DESCRIPTION	数量 AMT
1	#19、#25	279. 12-05	五线线架组件	Thread Stand Complete.	1
	#16	279. 12-06	六线线架组件	Thread Stand Complete.	1
	#27	279. 12-04	四线线架组件	Thread Stand Complete.	1
				<p>Note: #16...For -6专用 #19...For -4不用 #25...For -6不用 #27...For -4专用</p>	

20. 附件 ACCESSORIES PARTS

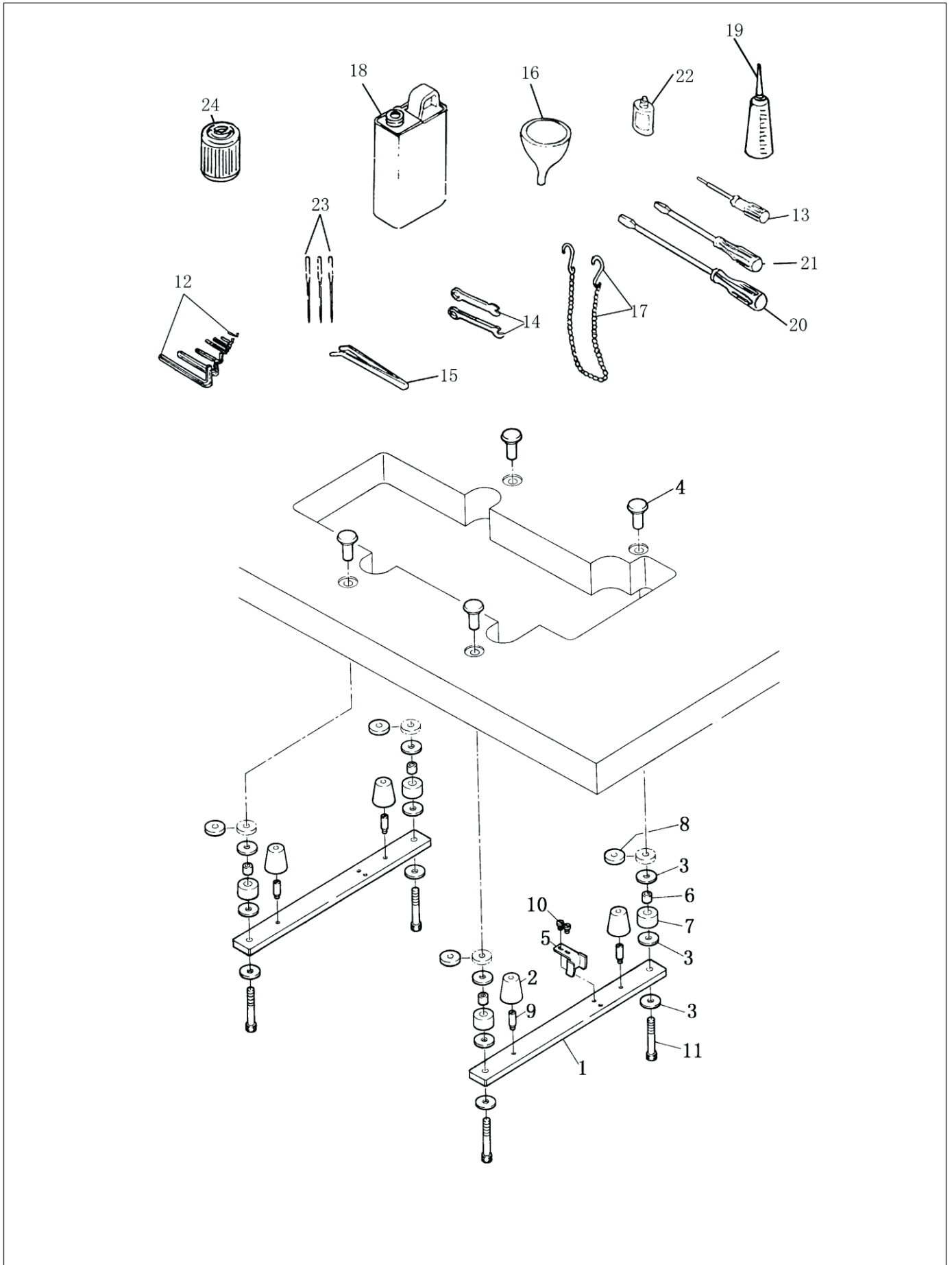

20. 附件 ACCESSORIES PARTS

序号 NO.	注解 NOTE	图号 REF NO.	名称	DESCRIPTION	数量 AMT
1		301.20-01	承重板	Bearing Plate	2
2		301.20-02	胶垫	Space Ring	4
3		21-08515260-01	垫片	Washer	12
4		301.20-04	螺钉	Screw	4
5		301.20-05	护板	Protect Plate	1
6		301.20-06	胶垫骨架	Space Ring Frame Work	4
7		301.20-07	胶垫	Space Ring	4
8		301.20-08	塑料垫圈	Plastic Washer	4
9		301.20-09	螺钉	Screw	4
10		12-40500825-01	螺钉	Screw	2
11		12-60805522-01	长螺钉	Long Screw	4
12		301.20-13	内六角 S2	Within Six Foreland (2-6)	1
		301.20-15	内六角 S2.5		1
		301.20-26	内六角 S3		1
		301.20-27	内六角 S3.5		1
		301.20-28	内六角 S4		1
		301.20-29	内六角 S5		1
		301.20-30	内六角 S6		1
13		279.11-29	S1.5有柄内六角扳手	Hexagon Wrench S1.5	1
14		279.11-22	双头扳手S8	Two-head Driver(S7、S8)	1
		279.11-22B	双头扳手S7		1
15		279.11-24	小镊子	Tweezer	1
16		279.11-17	圆塑料漏斗	Filler	1
17		279.11-12	抬压脚链条	Chain	1
		279.11-11	链条勾		2
18		101.12-21	油壶	Oil Bottle	1
19		279.11-18	小油壶	Small Oil Bottle	1
20		279.11-15	螺丝刀(大)	Screw Driver (L)	1
21		279.11-15A	螺丝刀(中)	Screw Driver (M)	1
22		279.11-19	硅油壶	Oil Tang	1
23		301.06-24	机针	Needle	3
24		279.08-23	纸质滤油器	Pump Filter	1
25		301.20-20	大尼龙袋		1
26	#01	301.20-21	外箱(宝石) 61×40×61.5		1
	#28	301.20-21-1	外箱(宝石) 61×40×61.5		1
27	#01	301.20-22	附件箱59×38×7		1
	#28	301.20-22-1	附件箱59×38×7		1
28	#01	301.20-23	身桶59.5×38.5×49.5		1
	#28	301.20-23-1	身桶59.5×38.5×49.5		1
29	#01	301.20-31	泡沫组件		1
	#28	301.20-34	泡沫组件		1
30		301.20-32	说明书	Operation Instruction & Parts Book	1
		301.20-33	零件样本		1
31		44-00000011-00	合格证		1

Note:
#01...For -7不用
#28...For -7专用

21. 导布部件 FABRIC GUIDE COMPONENTS

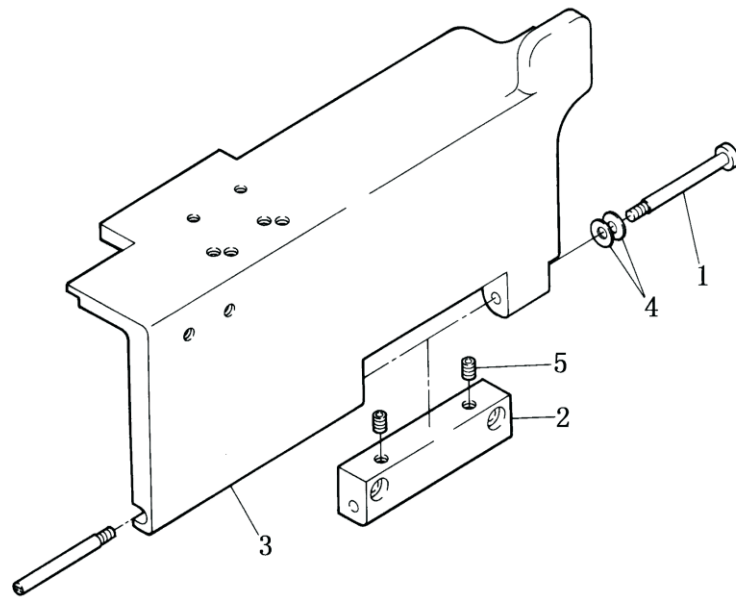

21. 导布部件 FABRIC GUIDE COMPONENTS

序号 NO.	注解 NOTE	图号 REF NO.	名称	DESCRIPTION	数量 AMT
1		301.02-13	长螺钉	Long Screw	1
2	#29	301.21-03	穿线链	Hinge Thread Guide Lath	1
3	#05、#29	301.21-04	穿线罩板	Thread Guide Plate	1
4		22-05000000-08	鞍形垫圈	Wave Washer	2
5		12-80500612-01	螺钉	Screw	2

Note:
 #05...For -5、-4不用
 #29...For -2、-02HY、-02DN、-02QG不用

22. (500B-02/02HY/02QG/02DN)专用部件
SPECIFIC PARTS (FOR 500B-02/02HY/02QG/02DN)

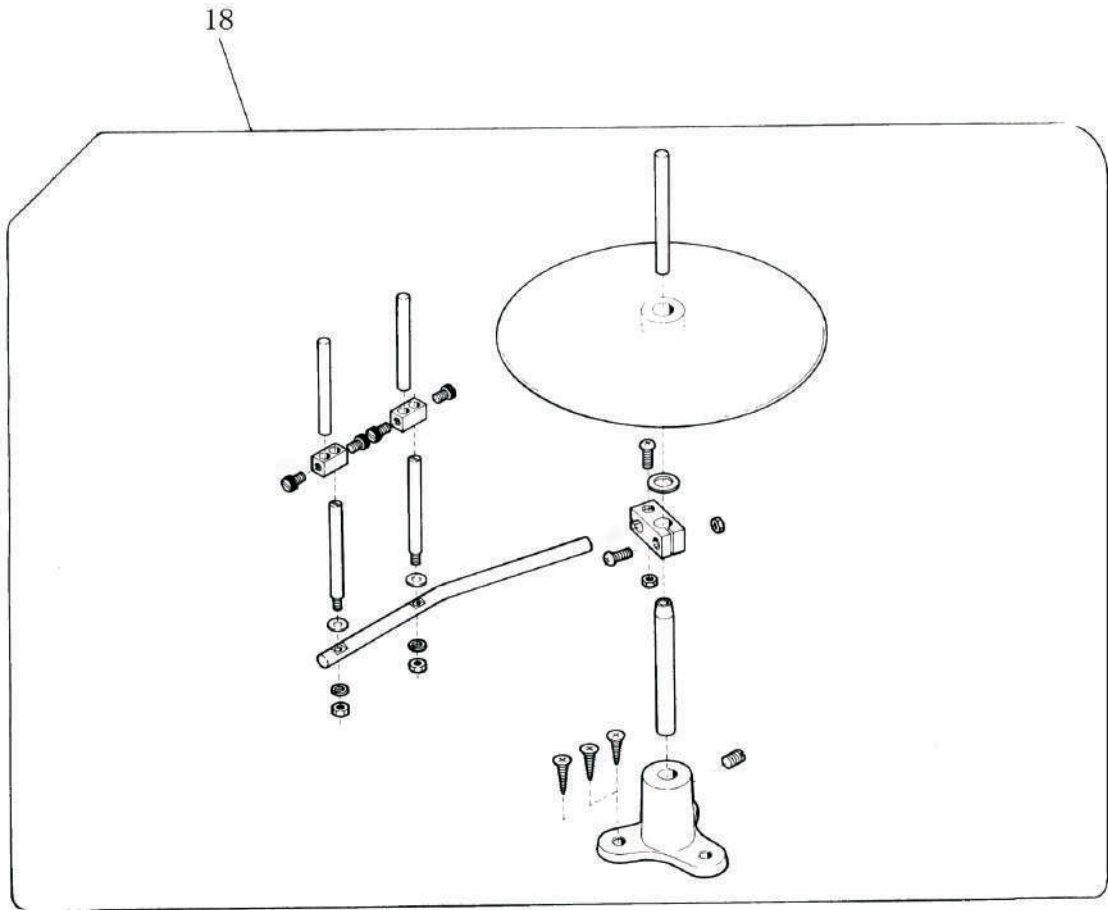
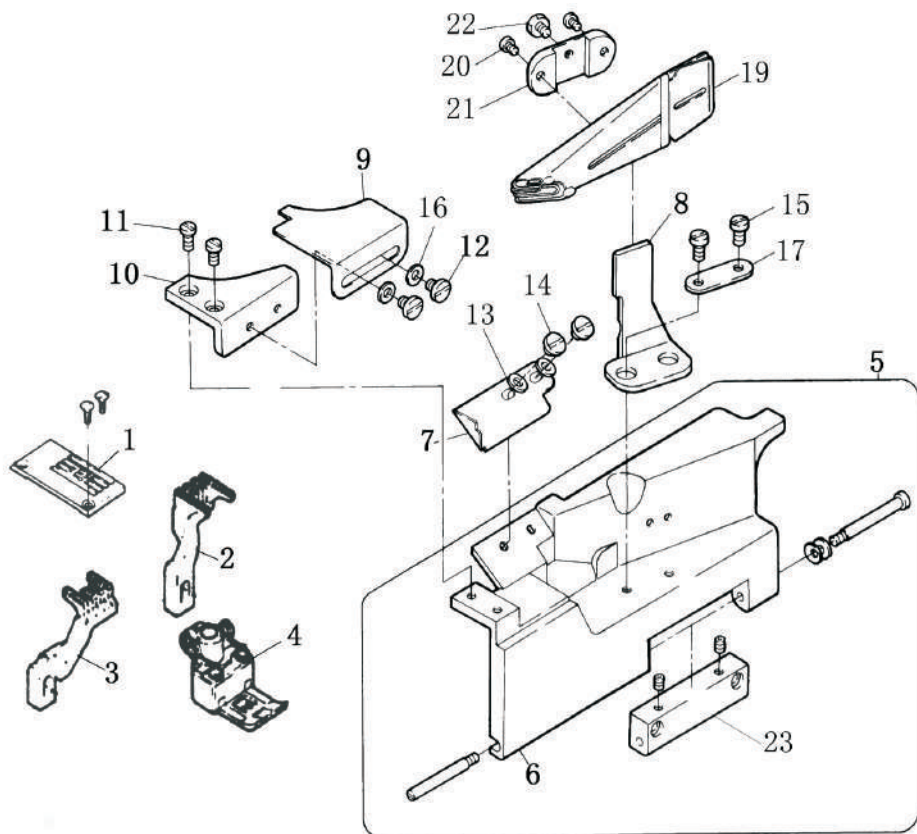

22. (500B-02/02HY/02QG/02DN)专用部件

SPECIFIC PARTS (FOR 500B-02/02HY/02QG/02DN)

序号 NO.	注解 NOTE	图号 REF NO.	名称	DESCRIPTION	数量 AMT
1		302.06-01	针板	Needle Plate	1
		302.06-01(6.4)	针板(6.4)	Needle Plate	1
2		302.09-01	主送布牙	Main Feed Dog	1
3		302.09-02	差动送布牙	Differential Feed Dog	1
4		302.11-00	压脚组件	Presser Foot Complete. (6.4)	1
		302.11-00(6.4)	压脚组件(6.4)	Presser Foot Complete.	1
		302.11-01	压脚柄	Presser Foot Handle	(1)
		302.11-02	压脚底板	Presser Foot Scaleboard	(1)
		302.11-03	压脚护板	Presser Foot Protect The Plank	(1)
		302.11-04	压脚连接柱	Pin	(1)
		302.11-05	压脚扭簧	Presser Foot Spring	(1)
		302.11-06	压脚扭簧螺钉	Screw	(1)
		302.11-07	压脚连接柱螺钉	Screw	(1)
		302.11-08	压脚销	Pin	(1)
		302.11-09	压脚压簧	Presser Foot Presser Spring	(1)
		302.11-10	压脚螺钉	Screw	(1)
5		302.23-00	穿线罩板组件	Thread Guide Plate Cover Complete	1
6		302.23-01	穿线罩板	Thread Guide Plate Cover	1
7		302.23-02	穿线罩板滚条护板(右)	Protect Plate(right)	1
8		302.23-03	穿线罩板滚条挡板	Bibcock Installation Bracket	1
9		302.23-04	穿线罩板滚条护板(左)	Protect Plate(left)	1
10		302.23-05	穿线罩挡线压板	Keep Off Thread Press Plate	1
11		12-40500825-01	穿线罩挡线压板螺钉	Keep Off Thread Press Plate Screw	2
		12-10400820-01	活动穿线罩板螺钉	Screw	1
12		12-40500625-01	穿线罩板护板(左)螺钉	Protect Plate(left) Screw	2
13		21-04308090-02	垫片	Washer	2
14		12-40400625-01	滚条护板(右)螺钉	Protect Plate(right) Screw	2
15		12-40601025-01	穿线罩板滚条挡板螺钉	Bibcock Installation Bracket Screw	2
16		21-05310100-02	垫片	Washer	2
17		302.23-12	穿线罩板滚条挡板垫片	Bibcock Installation Bracket Washer	1
18		302.23-07	滚边盘组件	Thread Stand Complete	1
		302.23-07-01	线架托盘	Spool Rest	(1)
		302.23-07-02	线架安装座	The Line Installs	(1)
		302.23-07-03	托盘安装棒	The Tray Installs The Strick	(1)
		302.23-07-04	短过线棒	Short Over Line Strick	(4)
		302.23-07-05	短过线棒安装座	Install Of Short Over Line Strick	(2)
		302.23-07-06	线架安装棒	The Line Installs The Stick	(1)
		302.23-07-07	线架安装棒安装座	Install Of The Line Installs The Stick	(1)
		302.23-07-08	线架托盘垫片	Spool Rest Cushion	(1)
		302.23-07-09	线架安装座螺钉	Screw	(1)
		302.23-07-10	紧定螺钉	Screw	(2)
		302.23-07-11	线架安装棒螺钉	Screw	(6)
		302.23-07-12	木螺钉	Screw	(3)
19		302.23-08	龙头组件(夹边器组件)	Bibcock Complete	1
20		12-40350525-01	夹线器固定板螺钉	Bibcock Fixing Plate Screw	2
21		302.23-09	夹线器固定板	Bibcock Fixing Plate	1
22		12-60501222-01	螺钉	Screw	1
23		302.23-13	穿线链	Hinge Thread Guide Lath	1

23. (500B-05)专用部件(1) SPECIFIC PARTS (1)(FOR 500B-05)

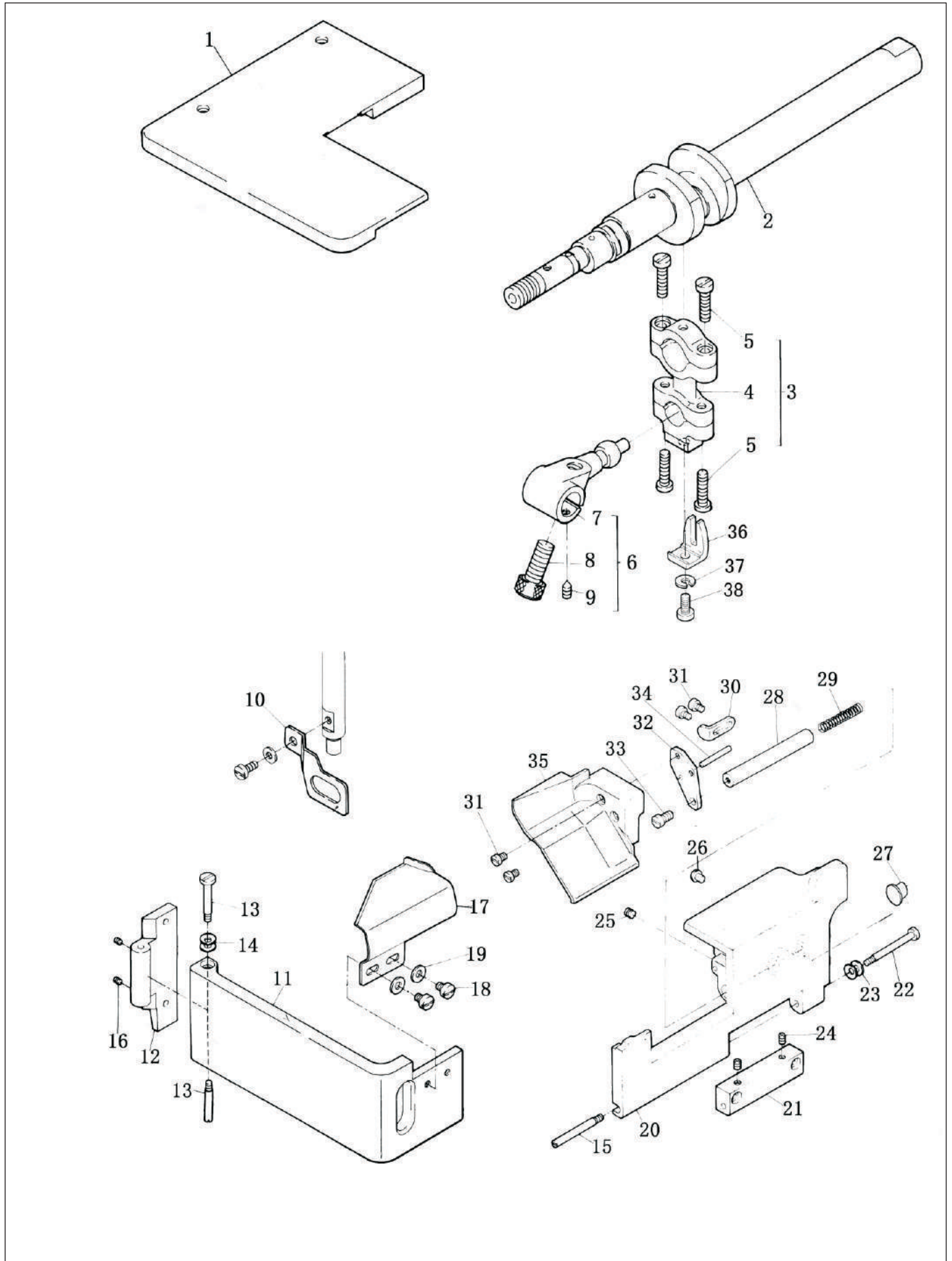

23. (500B-05)专用部件(1) SPECIFIC PARTS (1)(FOR 500B-05)

序号 NO.	注解 NOTE	图号 REF NO.	名称	DESCRIPTION	数量 AMT
1		311.24-01	缝台上盖	Sewing Plate Uper Cover	1
2		311.24-02	下轴前节	Lower Shaft Forepart	1
3		301.04-01	连杆组件	Looper Lever Complete Asm.	1
4		301.04-04	连杆	Looper Lever Complete	(1)
5		311.24-03-2	螺钉	Screw	(4)
6		311.24-04	曲柄组件	Looper Ball Crank Asm.	1
7		301.04-02	曲柄	Looper Ball Crank	1
8		12-65601422-01	螺钉	Screw	1
9		12-80300442-01	螺钉	Screw	1
10		311.24-05	护指架	Presser Bar Shield	1
11		311.24-06	左侧盖	Frontal Mantle	1
12		301.03-07	铰链	Hinge Board	1
13		301.03-06	螺钉	Hinge Link Screw	1
14		22-05000000-08	弹簧垫片	Spring Washer	2
15		301.02-01	销轴	Hinge Screw	1
16		12-80300412-01	螺钉	Screw	2
17		311.24-12	护料板	Protect Bat	1
18		12-40500625-01	螺钉	Secrew	2
19		21-05310100-02	垫圈	Washer	2
20		311.24-15	前盖	Frontal Mantle	1
21		301.21-03	铰链	Hinge Thread Guide Lath	1
22		301.02-13	螺钉	Long Screw	1
23		22-05000000-08	弹簧垫片	Wave Washer	2
24		12-80500512-01	螺钉	Screw	2
25		12-80500612-01	螺钉	Screw	1
26		301.02-17	孔塞	Shockproof Plug	1
27		311.24-23	塞子	Plug	1
28		311.24-24	轴	Shaft	1
29		311.24-25	弹簧	Spring	1
30		311.24-26	止动片	Stop Stir Piece	1
31		12-40400625-01	螺钉	Screw	2
32		311.24-28	支架	Bar Rock Shaft	1
33		12-40501025-01	螺钉	Screw	1
34		41-1030280000	销	Pin	1
35		311.24-31	前盖(小)	Frontal Mantle (small)	1
36		301.04-22	叉口	Fork	1
37		22-05000000-08	开口垫圈	Snap Rign	1
38		11-90110820-01	叉口螺钉	Fork Screw	1

24. (500B-05)专用部件(2) SPECIFIC PARTS (2) (FOR 500B-05)

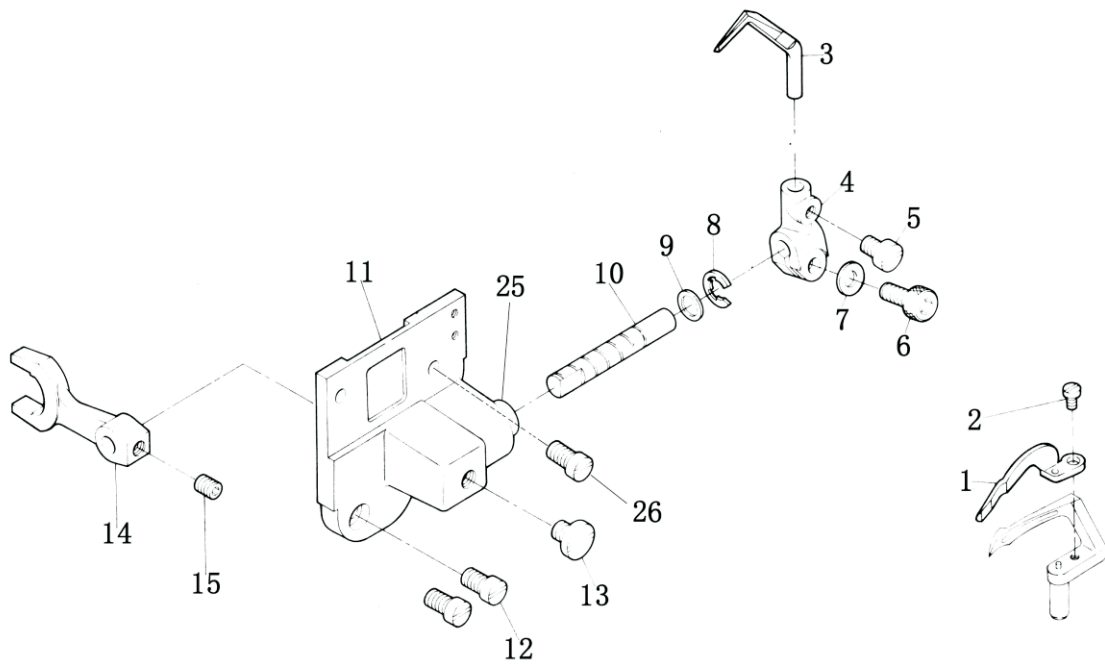

500B-05

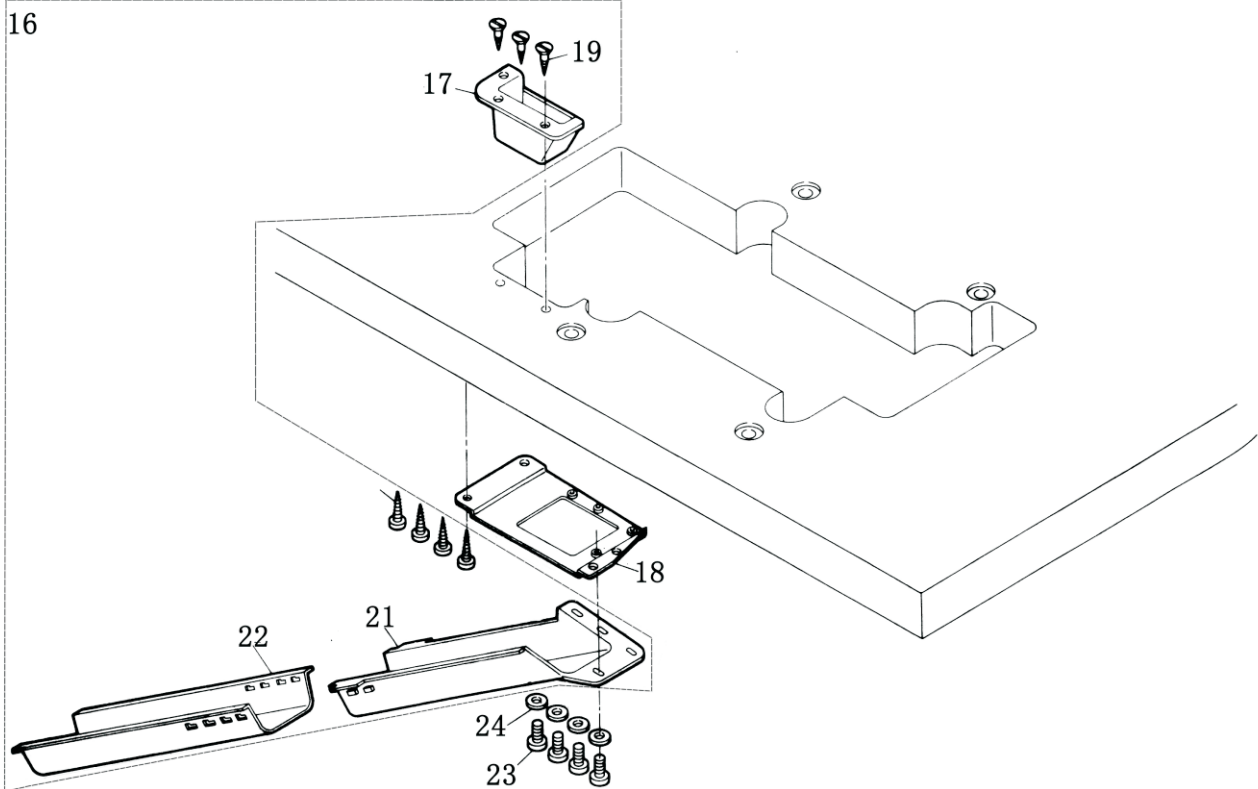

24. (500B-05)专用部件(2) SPECIFIC PARTS (2) (FOR 500B-05)

序号 NO.	注解 NOTE	图号 REF NO.	名称	DESCRIPTION	数量 AMT
1		301.07-21	护针(前)	Front Needle Guard	1
2		12-40250425-01	螺钉	Screw	1
3		301.07-03	护针(后)	Rear Needle Guard	1
4		311.25-04	杠杆	Hand Lifter Link	1
5		12-40400525-01	螺钉	Screw	1
6		12-60501022-01	螺钉	Screw	1
7		22-05000000-08	弹簧垫片	Washer	1
8		24-05000000-08	卡簧	Retaining Ring	1
9		21-06210101-01	垫圈	Washer	1
10		311.25-10	轴	Shaft	1
11		311.25-11	支架	Bar Rock Shaft	1
12		12-40400825-01	螺钉	Screw	2
13		12-60600420-01	螺钉	Screw	1
14		311.25-14	杠杆	Hand Lifter Link	1
15		12-80500512-01	螺钉	Screw	1
16		311.25-20	废料漏斗组件		1
17		311.25-16	废屑槽	Filler Chute	-1
18		311.25-18	支架	Bar Rock Shaft	1
19		311.25-19	螺钉	Screw	(7)
21		279.11-09	废屑流槽	Filler Chute (upper)	(1)
22		279.11-10	废屑流槽	Filler Chute(lower)	(1)
23		12-40401225-01	螺钉	Screw	4
24		21-04308090-02	垫圈	Washer	4
25		311.25-23	铜套	Copper Bushing	1
26		12-70400820-01	螺钉	Screw	1

25. (500B-05)专用部件(3) SPECIFIC PARTS (3) (FOR 500B-05)

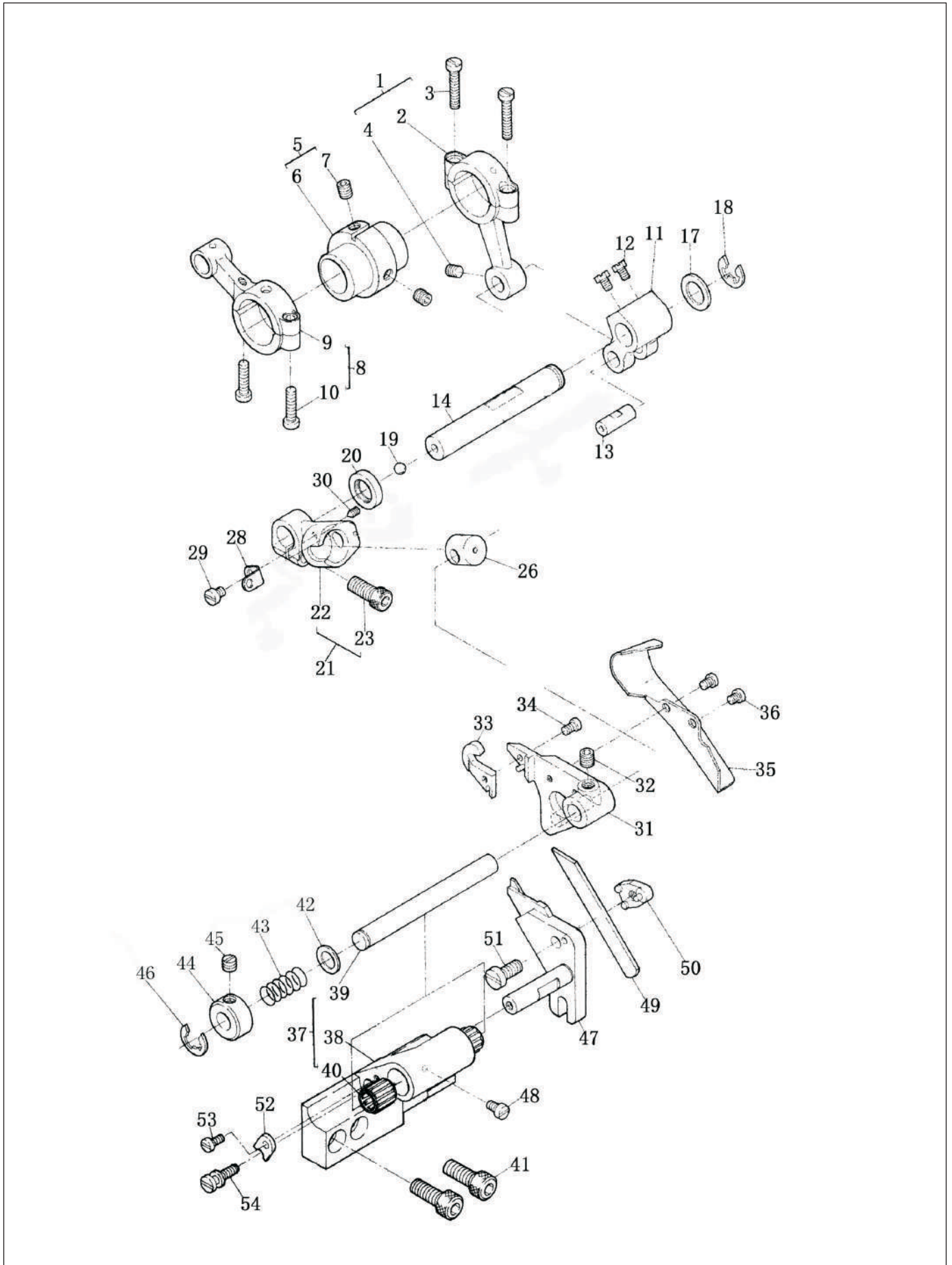

25. (500B-05)专用部件(3) SPECIFIC PARTS (3) (FOR 500B-05)

序号 NO.	注解 NOTE	图号 REF NO.	名称	DESCRIPTION	数量 AMT
1		301.07-04	连杆组件	Connecting Rod Asm.	1
2		301.07-04	连杆	Connecting Rod	(1)
3		11-40111425-01	螺钉	Screw	(2)
4		12-80400412-01	螺钉	Screw	1
5		311.26-02	偏心轮组件	Eccentric Cam Asm.	1
6		311.26-02-1	偏心轮	Eccentric Cam	1
7		12-80500612-01	螺钉	Screw	2
8		301.08-17	连杆组件	Looper Link Lever Asm.	1
9		301.08-17	连杆	Looper Link Lever	(1)
10		11-40091425-01	螺钉	Screw	(2)
11		301.07-01	曲柄	Needle Guard Crank	1
12		11-90110820-01	螺钉	Screw	2
13		301.07-10	销	Pin	1
14		311.26-07	轴	Shaft	1
17		21-10212142-01	垫圈	Washer	1
18		24-07000000-09	卡簧	Snap Thrust Ring	1
20		32-09430150-09	油封	Oil Seal	1
21		311.26-14	杠杆组件	Hand Lifter Link Asm.	1
22		311.26-14-1	杠杆	Hand Lifter Link	1
23		12-60501622-01	螺钉	Screw	1
26		311.26-17	滑块	Slide Block	1
28		311.26-19	销门	Pin	1
29		12-40300625-01	螺钉	Screw	1
30		12-80300442-01	螺钉	Screw	1
31		311.26-22	上切刀架	Upper Knife Bracket Asm.	1
		311.26-22-01	销	Pin	(1)
32		12-85600512-01	螺钉	Screw	1
33		311.26-24	上切刀	Upper Knife Bracket	1
34		11-60080620-01	螺钉	Screw	1
35		311.26-26	挡屑罩	Ward Off Scraps Cover	1
36		12-60300420-01	螺钉	Screw	2
37		311.26-28	支架组件	Bar Rock Shaft Asm.	1
38		311.26-28-1	支架	Bar Rock Shaft	1
39		311.26-28-2	轴	Shaft	1
40		311.26-28-3	滚针轴承	Needle Bearing	2
41		12-60601422-01	螺钉	Screw	2
42		21-08210162-03	垫圈	Washer	1
43		311.26-31	弹簧	Spring	1
44		301.11-21	紧圈	Thrust Ring	1
45		11-80110410-01	螺钉	Screw	1
46		24-06000000-08	卡簧	Clip Spring	1
47		311.26-35	下切刀架	Knife Bottom Bracket	1
48		12-40400625-01	螺钉	Screw	1
49		209.11-19	下刀片	Knife Bottom	1
50		311.26-38	下刀夹	Knife Bottom	1
51		12-40501025-01	螺钉	Screw	1
52		311.26-40	导向器	Lead Faver Ware	1
53		12-40300625-01	螺钉	Screw	1
54		311.26-42	螺钉	Screw	1

26. (500B-05)专用部件(4) SPECIFIC PARTS (4) (FOR 500B-05)

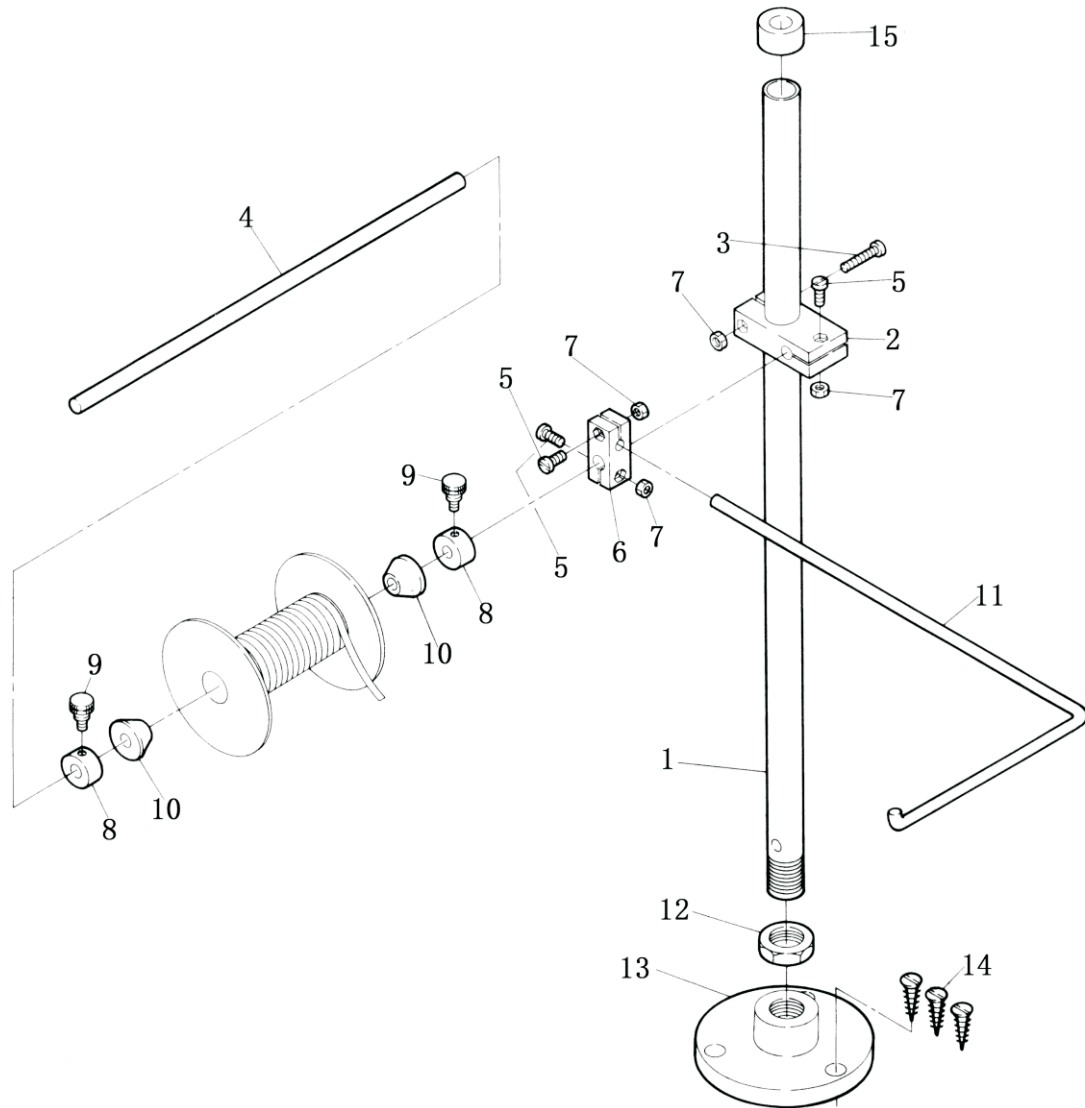

26. (500B-05)专用部件(4) SPECIFIC PARTS (4) (FOR 500B-05)

序号 NO.	注解 NOTE	图号 REF NO.	名称	DESCRIPTION	数量 AMT
1		311.28-01	杆	Hand Lifter Link	1
2		311.28-02	支架	Bar Rock Shaft	1
3		311.28-03	螺钉	Screw	1
4		311.28-04	棒	Stick	1
5		311.28-05	螺钉	Screw	3
6		311.28-06	固定器	Fixer	1
7		311.28-08	螺母	Nut	4
8		311.28-09	紧圈	Thrust Ring	2
9		311.28-10	螺钉	Screw	2
10		311.28-11	卷轴导向	Reel Lead Favor	2
11		311.28-12	辅助杆	Assistant Perch	1
12		311.28-15	螺母	Nut	1
13		311.28-16	线支架	Line Bar Rock Shaft	1
14		311.28-17	螺钉	Screw	3
15		311.28-18	塑料帽	Plastic Cap	1

27. (500B-05)专用部件(5) SPECIFIC PARTS (5) (FOR 500B-05)

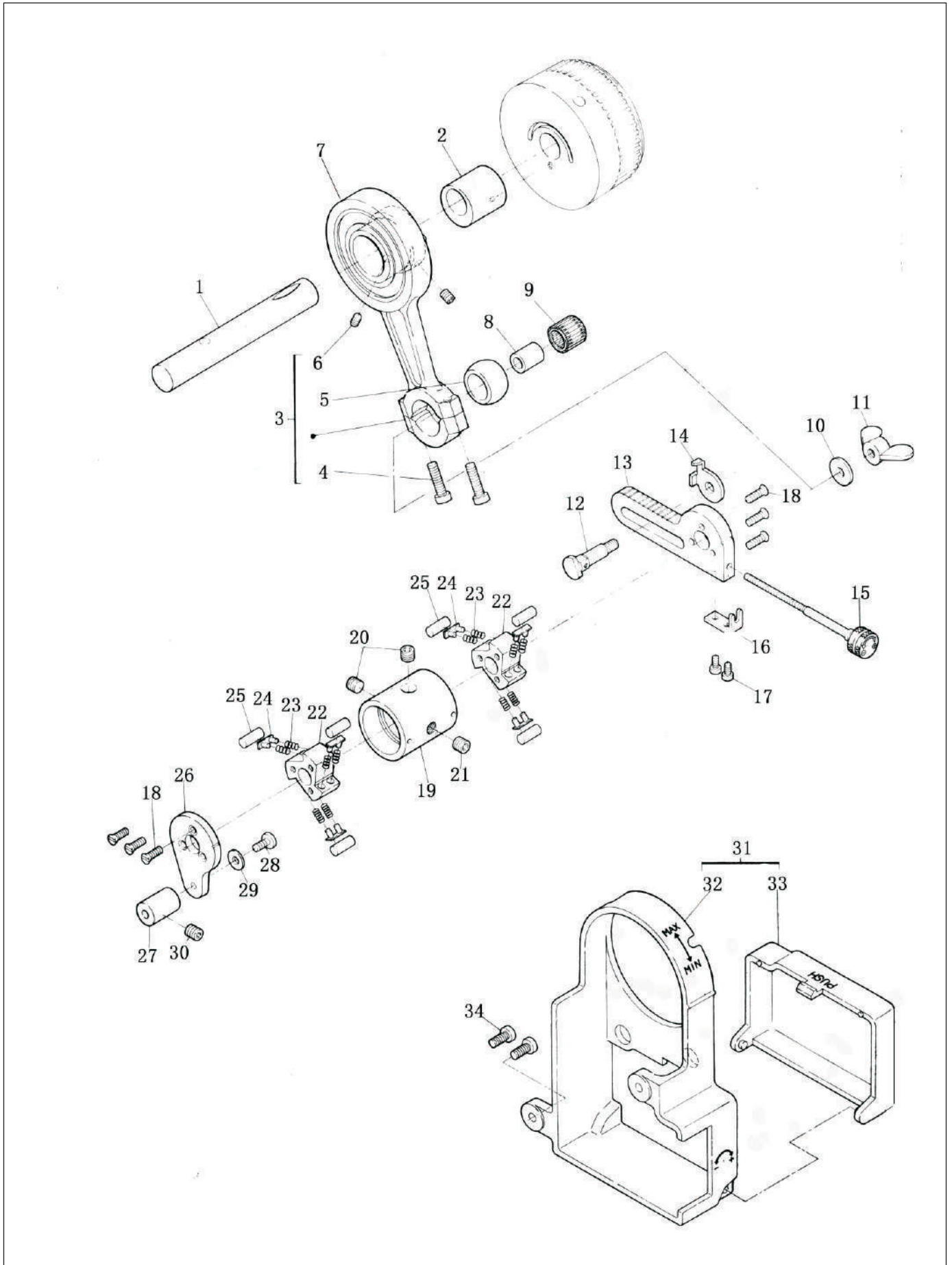

27. (500B-05)专用部件(5) SPECIFIC PARTS (5) (FOR 500B-05)

序号 NO.	注解 NOTE	图号 REF NO.	名称	DESCRIPTION	数量 AMT
1		311.29-01	上轴后节	Main Shaft Backside	1
2		311.29-02	偏心轮组件	Eccentricity Asm.	1
		311.29-02-1	偏心轮	Eccentricity	1
		311.29-02-2	偏心轮	Eccentricity	1
3		311.29-03	连接组件	Link Asm.	1
		311.29-03-01	轴承	Bearing	1
4		12-40401625-01	螺钉	Screw	(2)
5		311.29-03-2	球轴	Sphere Shaft	1
6		12-80500512-01	螺钉	Screw	2
7		311.29-03-4	连接上盖		(1)
		311.29-03-5	联接连杆		(1)
8		311.29-04	轴套	Bushing	1
9		311.29-05	滚针轴承	Needle Bearing	1
10		21-06215162-03	垫圈	Washer	1
11		311.29-07	螺母	Nut	1
12		311.29-08	销	Pin	1
13		311.29-09	曲柄	Brace	1
14		311.29-10	显示器	Display	1
15		311.29-11	螺钉	Screw	1
16		311.29-12	止动板	Stop Stir Board	1
17		12-40300625-01	螺钉	Screw	2
18		12-10401120-01	螺钉	Screw	6
		311.29-15-00	棘轮组件		1
19		311.29-15	轴套	Bushing	1
20		12-80600812-01	螺钉	Screw	2
21		12-80600812-01	螺钉	Screw	1
22		311.29-18	离合器	Clutch	2
23		311.29-19	弹簧	Spring	12
24		311.29-20	导向板组件	Guide Favor Board	6
25		311.29-21	销	Pin	6
26		311.29-22	止动板	Stop Stir Board	1
27		311.29-24	销	Pin	1
28		11-40110825-01	螺钉	Screw	1
29		21-04508080-01	垫圈	Washer	1
30		12-80500512-01	螺钉	Screw	1
31		311.29-28	盖(组件)	About Asm.	1
32		311.29-28-1	盖	About	1
33		311.29-28-2	盖	About	1
34		12-40401025-01	螺钉	Screw	2

28. (500B-05)专用部件(6) SPECIFIC PARTS (6)(FOR 500B-05)

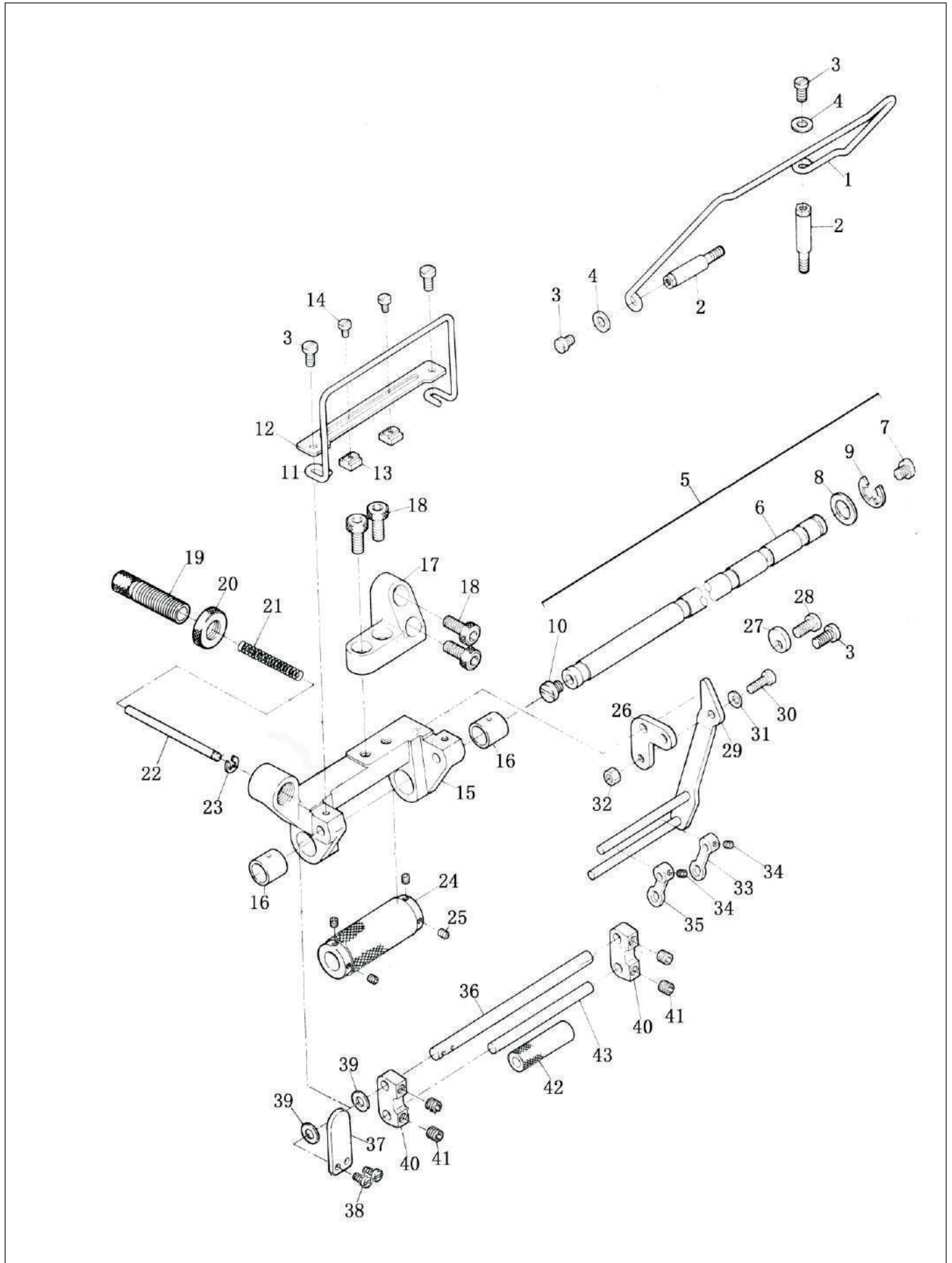

28. (500B-05)专用部件(6) SPECIFIC PARTS (6)(FOR 500B-05)

序号 NO.	注解 NOTE	图号 REF NO.	名称	DESCRIPTION	数量 AMT
1		311.30-01	花边导向器	Lace Lead Faver Ware	1
2		311.30-02	螺钉	Screw	2
3		12-40400825-01	螺钉	Screw	5
4		21-05310100-02	垫圈	Washer	2
5		311.30-05-01	轴组件	Shaft Asm.	1
6		311.30-05-1	轴	Shaft	1
7		12-60500520-01	螺钉	Screw	2
8		21-10212142-01	垫圈	Washer	1
9		24-08000000-08	卡簧	Retaining Ring	1
11		311.30-06	花边导向器	Screw	1
12		311.30-07	导向器	Lace Lead Faver Ware	1
13		311.30-09	滑块	Block	2
14		11-70060520-01	螺钉	Screw	2
15		311.30-11	支架	Bar Rock Shaft	1
16		311.30-12	轴套	Bushing	3
17		311.30-13	支架	Bar Rock Shaft	1
18		12-60601422-01	螺钉	Screw	4
19		311.30-16	螺钉	Screw	1
20		311.30-17	调节螺母	Nut	1
21		311.30-18	弹簧	Spring	1
22		311.30-19	轴	Shaft	1
23		24-03000000-08	卡簧	Retaining Ring	1
24		311.30-21	滚柱组件	Roll Mast Asm.	1
25		12-80300412-01	螺钉	Screw	4
26		311.30-23	支架	Bar Rock Shaft	1
27		311.30-24	止动片	Stop Stir Piece	1
28		12-40401025-01	螺钉	Screw	1
29		311.30-27	支架组件	Bar Rock Shaft Asm.	1
		311.30-27-01	托架柄		(1)
		311.30-27-02	托架杆		(2)
30		12-40401225-01	螺栓	Bolt	1
31		23-05003090-09	弹簧垫圈	Washer	1
32		14-60403020-01	螺母	Nut	1
33		311.30-31	花边导向器	Lace Lead Faver Ware	1
34		12-80300312-01	螺钉	Screw	2
35		311.30-33	花边导向器	Lace Lead Faver Ware	1
36		311.30-35	轴	Shaft	1
37		311.30-36	杠杆	Hand Lifter Link	1
38		12-40300625-01	螺钉	Screw	2
39		21-06510120-01	垫圈	Washer	2
40		311.30-39	支架	Bar Rock Shaft	2
41		12-80500512-01	螺钉	Screw	4
42		311.30-41	滚柱	Roll Mast	1
43		311.30-42	轴	Shaft	1
44		31-14818000-09	O形圈	O-ring	1
45		12-80500512-01	前套螺钉	Front Bushing Screw	2
46		311.05-1	带轮		1
47		311.06-1	针板		1
48		311.09-45	差动送布牙		1
49		311.09-46	主动送布牙		1
50		311.11-38	压脚		1

29. (500B-02HY)专用部件 SPECIFIC PARTS (FOR 500B-02HY)

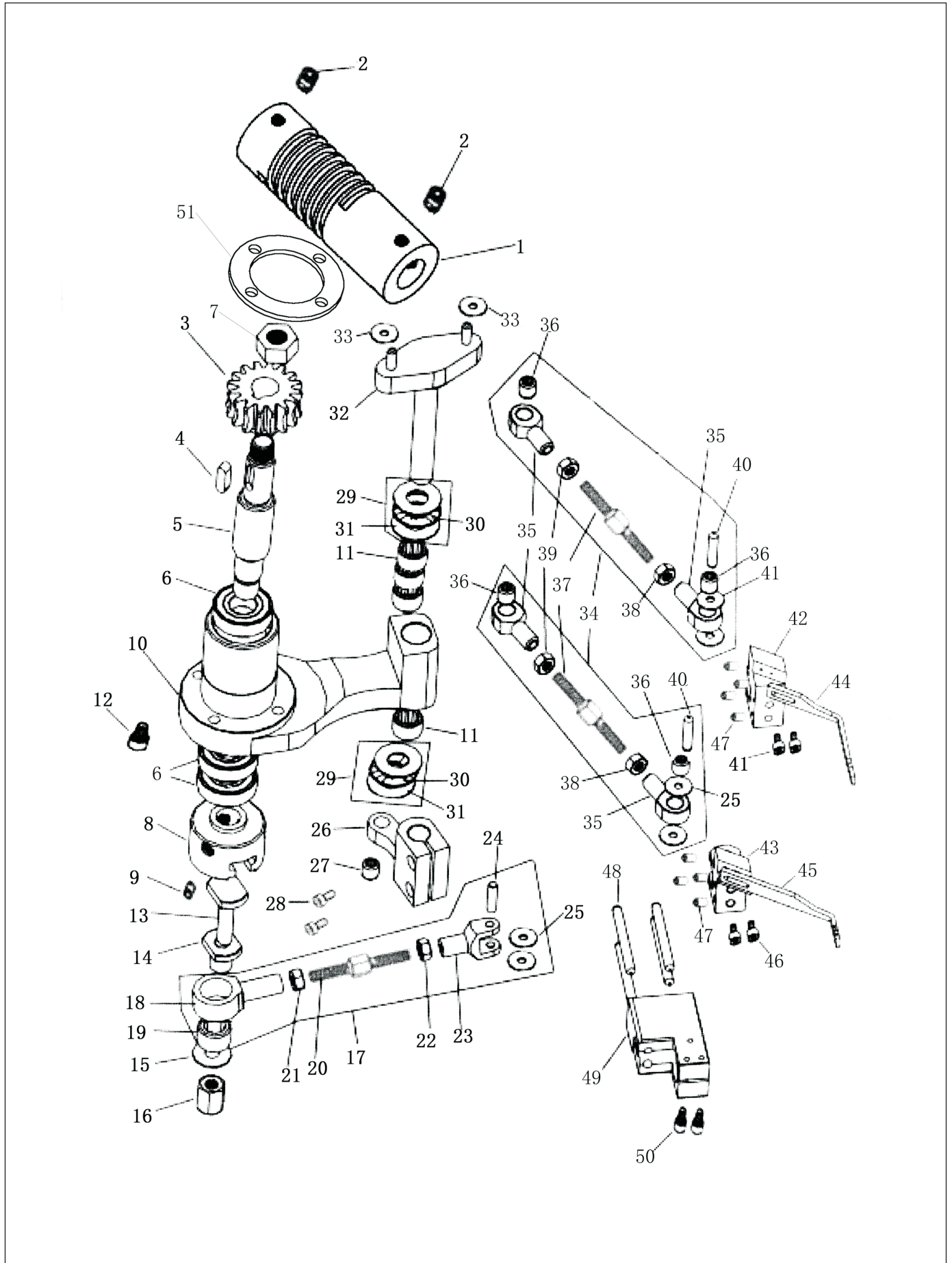

29. (500B-02HY)专用部件 SPECIFIC PARTS (FOR 500B-02HY)

序号 NO.	注解 NOTE	图号 REF NO.	名称	DESCRIPTION	数量 AMT
1		338.01-01	蜗杆	Worm	1
2		12-80600812-01	蜗杆紧定螺钉	Worm Fixing Nut	6
3		338.01-02	蜗轮	Worm Wheel	1
4		338.01-03	蜗轮花键	Worm Wheel Spline	1
5		338.01-04	蜗轮轴	Worm Wheel Shaft	1
6		338.01-05	蜗轮轴承 $\phi 15 \times \phi 32 \times 9$	Worm Wheel Shaft Bearing $\phi 15 \times \phi 32 \times 9$	3
7		338.01-06	蜗轮轴螺母	Worm Wheel Shaft Nut	1
8		338.01-07	偏心轮	Eccentricity Wheel	1
9		12-80801212-01	偏心轮紧定螺钉	Eccentricity Wheel Fixing Screw	3
10		338.01-08	支承架	Supporting Stand	1
11		338.01-08-01	滚针轴承 $\phi 12 \times \phi 16 \times 10$	Needle Bearing $\phi 12 \times \phi 16 \times 10$	4
12		12-60602022-01	支架固定螺钉	Stand Fixing Screw	4
13		338.01-09	摆动销A	Swing Pin A	1
14		338.01-10	摆动销B	Swing Pin B	1
15		338.01-11	摆动销垫片	Swing Pin Washer	1
16		338.01-12	摆动销螺母	Swing Washer Nut	1
17		338.01-13	摆动连杆组件	Swing Connecting Rod Asm	1
18		338.01-13-01	连杆A	Connecting Rod	1
19		338.01-08-01	连杆A轴承	Connecting Rod Bearing	1
20		338.01-13-03	拉杆	Lever	1
21		14-60605020-02	拉杆螺母	Lever Nut	1
22		338.01-13-05	拉杆螺母	Lever Nut (left)	1
23		338.01-13-06	连杆B	Connecting Rod B	1
24		338.01-13-07	连杆B连接销	Connecting Rod B Connecting Pin	1
25		338.01-13-08	垫片	Washer	2
26		338.01-14	摆动曲柄	Swing Crank	1
27		338.01-14-01	滚针轴承 $\phi 5 \times \phi 9 \times 9$	Needle Bearing	1
28		12-60501622-01	摆动曲柄螺钉	Swing Crank Screw	2
29		338.01-16	平面推力滚针组件	Horizontal Pushing Needle Bearing Asm	2
30		279.03-07	平面推力滚针	Horizontal Pushing Needle Bearing	2
31		279.03-07	推力滚针垫片 $\phi 12 \times \phi 26 \times 10$	Pushing Needle Bearing Washer	4
32		338.01-17	摆动轴组件	Swing Shaft Asm	1
33		338.01-13-08	垫片	Washer	2
34		338.01-19	拉杆组件	Lever Asm	2
35		338.01-19-01	拉杆接头	Lever Connector	4
36		338.01-19-02	拉杆接头滚针 $\phi 5 \times \phi 9 \times 9$	Lever Connector Needle Bearing $\phi 5 \times \phi 9 \times 9$	4
37		338.01-19-03	拉杆	Lever	2
38		338.01-13-05	拉杆螺母	Lever Nut	2
39		14-60605020-02	拉杆螺母	Lever Nut (right)	2
40		338.01-19-06	拉杆销	Lever Pin	2
41		338.01-13-08	垫片	Washer	4
42		338.01-20	拨线座A	Drawing Thread Set A	1
43		338.01-21	拨线座B	Drawing Thread Set B	1
44		338.01-22	拨线杆A	Drawing Thread Bar A	1
45		338.01-23	拨线杆B	Drawing Thread Bar B	1
46		12-60301022-01	拨线杆固定螺钉	Drawing Thread Bar Fixing Screw	4
47		12-80400412-01	拨线座螺钉	Drawing Thread Set Screw	8
48		338.01-26	拨线座定位销	Drawing Thread Posion Pin	4
49		338.01-27	拨线座定位块	Drawing Thread Set Posion Plate	1
50		12-60402522-01	拨线座定位块固定螺钉	Drawing Thread Set Posion Plate Fixing Screw	2
51		338.01-47	垫片	Washer	1

29. (500B-02HY)专用部件 SPECIFIC PARTS (FOR 500B-02HY)

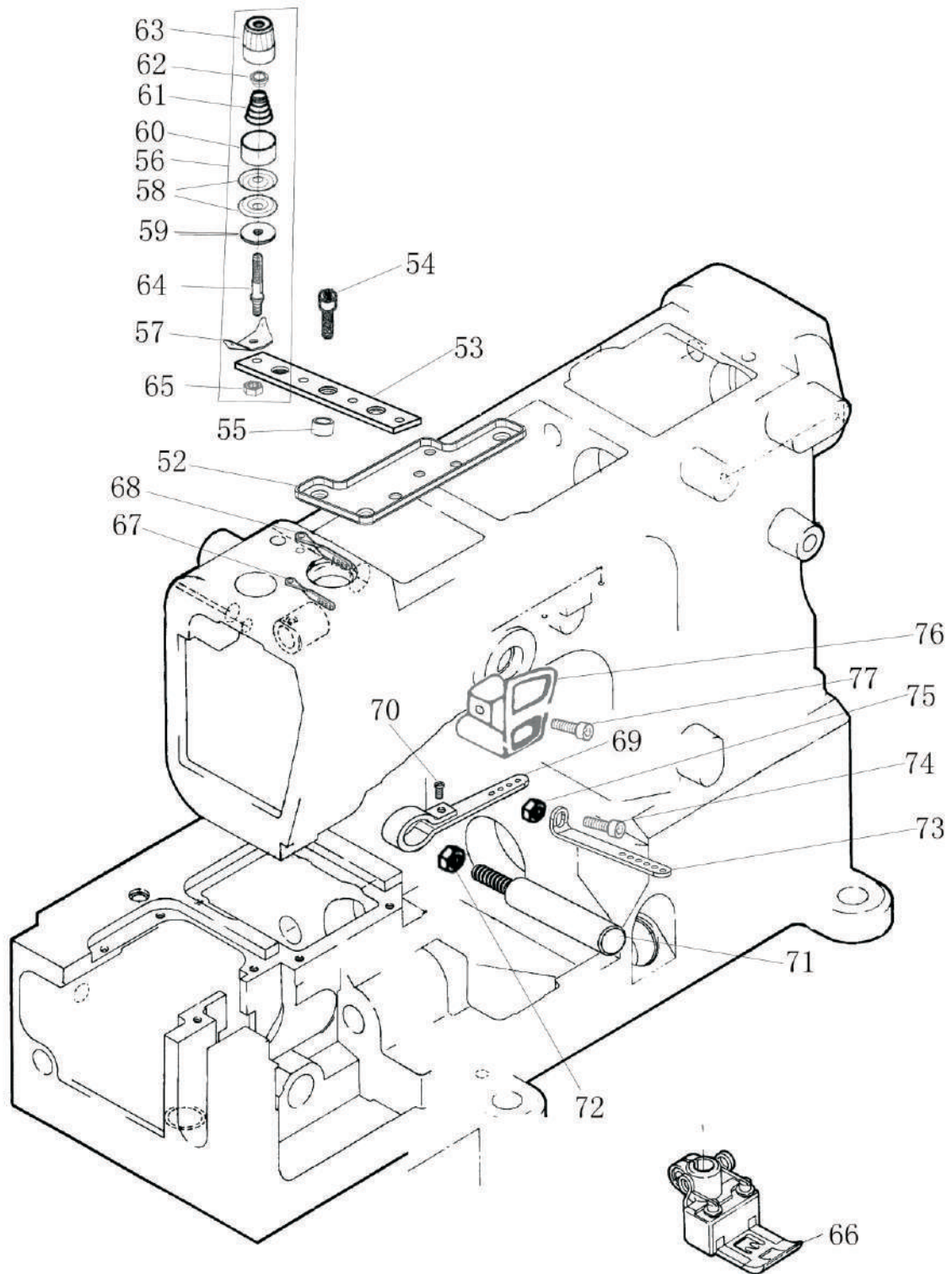

29. (500B-02HY)专用部件 SPECIFIC PARTS (FOR 500B-02HY)

序号 NO.	注解 NOTE	图号 REF NO.	名称	DESCRIPTION	数量 AMT
52		304.16-01	小油盘	Small Oil Pan	1
53		338.01-30	压线座固定架	Press Fixing Bracket	1
54		12-60501622-01	压线座固定架螺钉	Press Fixing Bracket Screw	1
55		338.01-32	压线座固定架垫片	Press Fixing Bracket Washer	3
56		338.01-33	压线器组件	Presser Asm	4
57		203.01-22	过线板	Thread Guide Plate	4
58		301.13-10	夹线板	Thread Tension Plate	8
59		338.01-33-03	羊毛毡	Wool Felt	4
60		301.13-15	夹线座	Thread Tension Set	4
61		301.13-18	夹线弹簧	Thread Tension Spring	4
62		301.13-11	夹线防松圈	Thread Tension Protect Loosing Ring	4
63		301.13-12	夹线螺母	Thread Tension Screw	4
64		301.13-25	夹线螺钉	Nut	4
65		14-60403020-01	螺母M4	Presser Foot Complete	4
66		338.01-34	压脚组件	Presser Foot Complete	1
		338.01-34-01	压脚座	Presser Foot Bracket	(1)
		338.01-34-02	压杆座	Presser Bar Bracket	(1)
		338.01-34-03	压脚	Presser Foot Complete	(1)
		338.01-34-04	压脚压板	Presser Foot Plate	(1)
		338.01-34-05	压脚接头	Presser Foot Connector	(1)
		302.11-08	压脚销	Presser Foot Pin	(1)
		338.01-34-07	压脚接头销	Presser Foot Connection Pin	(1)
		338.01-34-08	压杆座弹簧	Presser Bar Bracket Spring	(1)
		338.01-34-09	压脚压簧	Presser Foot Press Sping	(1)
		338.01-34-10	压杆座调节螺钉	Presser Bar Set Regulating Screw	(1)
		338.01-34-11	压簧螺钉	Presser Spring Screw	(2)
		338.01-34-12	压脚压板螺钉	Presser Foot Pressing Plate Screw	(1)
		338.01-34-13	压杆座销紧定螺钉	Presser Bar Fixing Screw	(1)
		338.01-34-14	调节螺钉螺母	Regulating Screw Nut	(1)
67		338.01-35	上过线勾A	Upper Thread Guide Finger A	2
68		338.01-36	上过线勾B	Upper Thread Guide Finger B	1
69		338.01-37	下过线勾A	Lower Thread Guide Finger A	1
70		12-60400822-01	下过线勾A螺钉	Lower Thread Guide Finger A Screw	1
71		338.01-39	下过线勾A支柱	Lower Thread Guide Finger A Stand	1
72		14-60403020-01	下过线勾A支柱螺母	Lower Thread Guide Finger A Stand Screw	1
73		338.01-41	下过线勾B	Lower Thread Guide Finger B	1
74		12-60400822-01	下过线勾B螺钉	Lower Thread Guide Finger B Screw	1
75		14-60403020-01	下过线勾B螺母	Lower Thread Guide Finger B Screw	1
76		338.01-44	挑线杆防护罩	Thread Take-up Lever Shaft Shield	1
77		12-40401225-01	螺钉	Screw	2
78		338.01-46	油杯	Oil Cup	1

30. (500B-04)专用部件 SPECIFIC PARTS (FOR 500B-04)

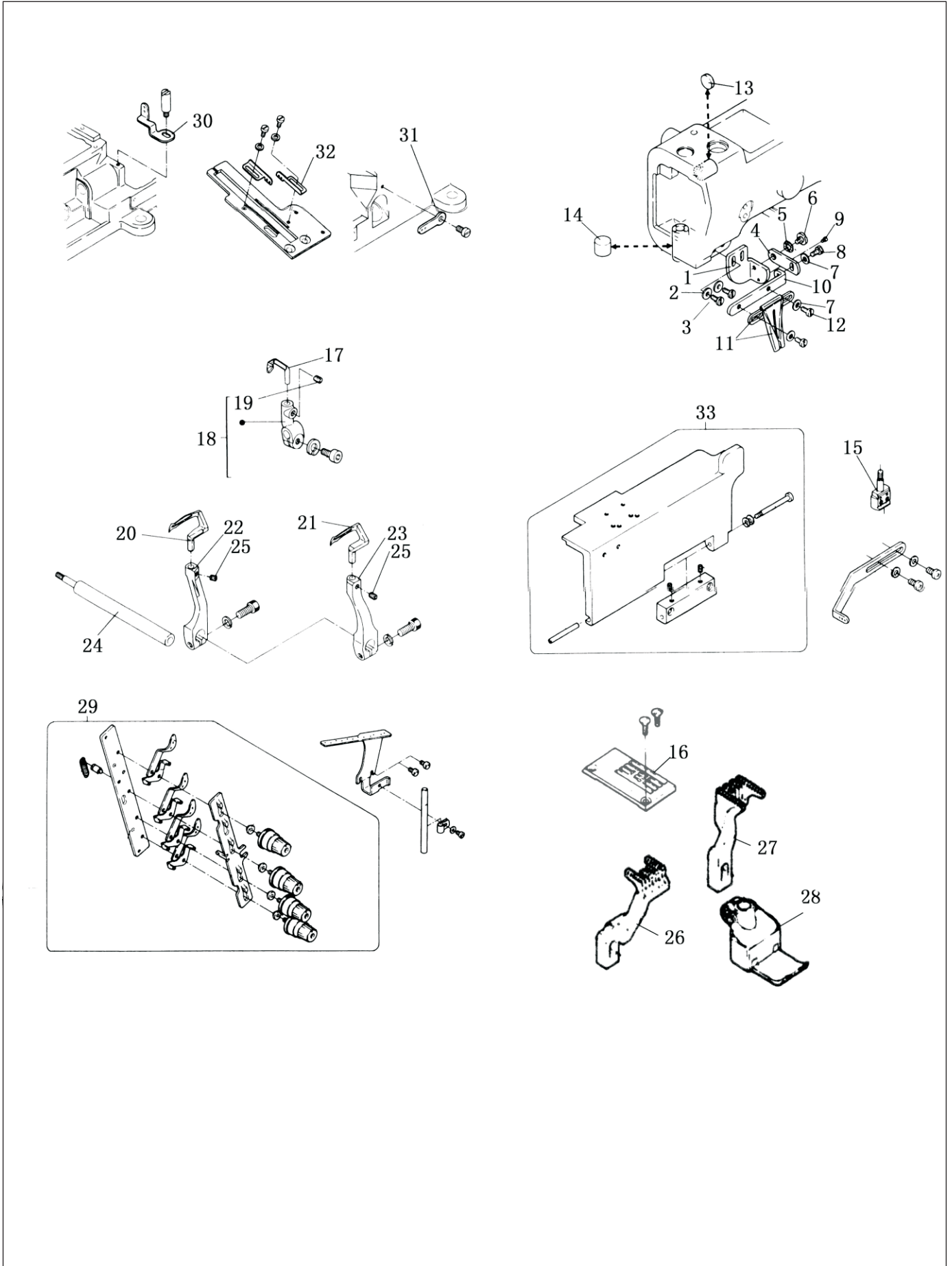

30. (500B-04)专用部件 SPECIFIC PARTS (FOR 500B-04)

序号 NO.	注解 NOTE	图号 REF NO.	名称	DESCRIPTION	数量 AMT
1		310.33-01	卷边龙头支座	Folder Bracket	1
2		21-04308090-02	垫片	Washer	2
3		12-40400825-01	螺钉	Screw	2
4		310.33-04	侧板	Side Plate	1
5		23-06405110-09	鞍型垫圈	Wave Washer	1
6		301.02-25	螺钉	Screw	1
7		21-04308090-02	垫片	Washer	3
8		12-90400723-01	外六角螺钉	Svrew	1
9		310.33-09	定位螺钉	Orientation Screw	1
10		310.33-10	卷边龙头固定板	Folder Fixing Plate	1
11		310.33-11	卷边龙头	Folder	1
12		12-40400625-01	螺钉	Screw	2
13		304.01-25	绷针横轴油塞	Oil Seal For Spreader Crossing Shaft	1
14		310.33-14	绷针竖轴油堵	Oil Seal For Spreader Uprinat Shaft	1
15		310.33-15	针夹	Needle Holder	1
		310.33-15(7.2)	针夹	Needle Holder	1
16		310.33-16	针板	Needle Plate	1
		310.33-16(7.2)	针板	Needle Plate	1
17		310.33-17	后保针	Rear Needle Guard	1
18		310.33-18	保针座	Needle Guard Base	1
19		12-80400412-01	螺钉	Screw	1
20		310.33-20	左弯针	Left Looper	1
21		310.33-21	右弯针	Right Looper	1
22		310.33-22	左弯针曲柄	Left Looper Crank	1
23		310.33-23	右弯针曲柄	Right Looper Crank	1
24		310.33-24	弯针轴	Looper Shaft	1
25		12-80400412-01	弯针刀槽螺钉	Looper Groove Screw	2
26		310.33-26	差动送布牙	Differential Feed Dog	1
		310.33-26(7.2)	差动送布牙	Differential Feed Dog	1
27		310.33-27	主动送布牙	Main Feed Dog	1
		310.33-27(7.2)	主动送布牙	Main Feed Dog	1
28		310.33-28	压脚(组件)	Presser Foot Arm.	1
		310.33-28-01	压脚座		(1)
		310.33-28-02	压脚		(1)
		310.33-28-03	销	Pin	(2)
		310.33-28(7.2)	压脚(组件)	Presser Foot Arm.	1
		310.33-28-01	压脚座		(1)
		310.33-28-02(7.2)	压脚底板		(1)
		310.33-28-03	销	Pin	(2)
29		310.33-29	夹线器大组件	Thread Tension Spring Arm.	1
30		310.33-30	过线板	Thread Guide Plate	1
31		310.33-31	过线板	Thread Guide Plate	1
32		310.33-32	下过线板	Lower Thread Guide Plate	2
33		301.21-04	穿线罩板	Thread Guide Plate	1
34		279.12-04	线架组件		1

31. (500B-21)专用部件SPECIFIC PARTS FOR (500B-21)

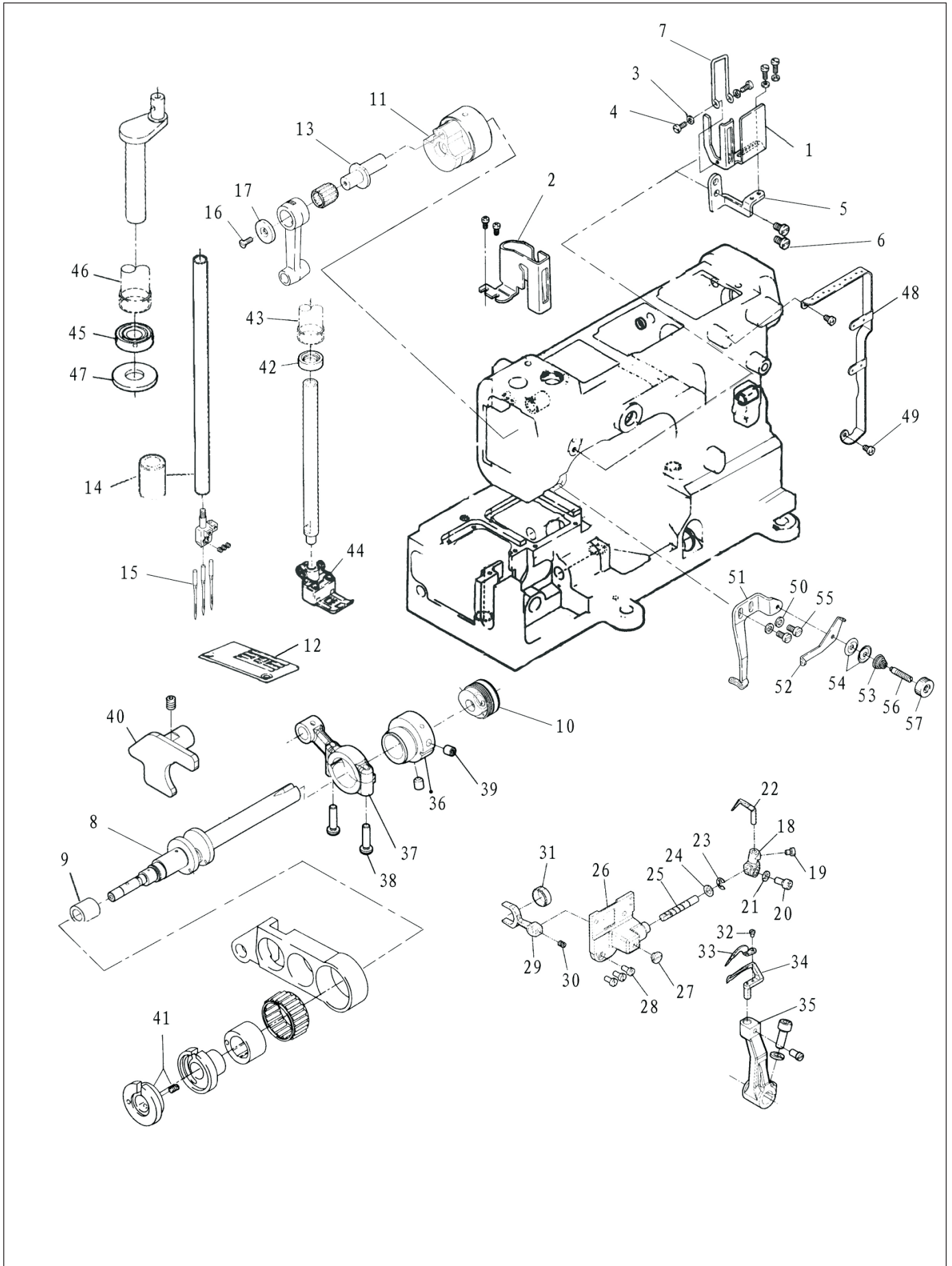

31. (500B-21)专用部件SPECIFIC PARTS FOR (500B-21)

序号 NO.	注解 NOTE	图号 REF NO.	名称	DESCRIPTION	数量 AMT
1		340.02-07	挑线防护罩	Threading Cover Spring	1
2		340.02-09	上挑线罩座	Thread Take—up Lever Guard	1
3		21-04308090-02	垫片	Washer	4
4		12-40400625-01	螺钉	Screw	4
5		340.02-34	护板支架	Shield Bracket	1
6		12-40601025-01	螺钉	Screw	2
7		340.02-36	挑线防护罩钢丝	Pick The Line Protection Cover Steel Wire	1
8		340.04-10	下轴前轴节	Lower Shaft Forepart	1
9		343.04-30	下轴前套	Lower Shaft Front Bushing	1
10		343.04-09	下轴前衬套组件	Lower Shaft Front Bushing Asm.	1
		301.19-09	轴承	Berings	1
		343.04-09-02	下轴前衬套	Lower Shaft Front Bushing	1
		31-32014000-09	O型圈	O-ring	2
11		340.05-14	针杆曲柄	Needle Bar Crank	1
12		340.06-02	针板	Needle Plate	1
13		340.06-15	针杆连接销	Needle Bar Connecting Pin	1
14		340.06-18	针杆下套	Needle Bar Lower Bushing	1
15		340.06-24	机针	Needl Uy128gas #12s	3
16		12-10300620-01	螺钉	Screw	1
17		340.06-27	垫片	Washer	1
18		311.25-04	护针座	Needle Guard Base	1
19		12-40400525-01	螺钉	Screw	1
20		12-60501022-01	护针座螺钉	Needle Guard Base Screw	1
21		22-05000000-08	弹性垫圈	Washer	1
22		301.07-03	后护针	Rear Needle Guard	1
23		24-05000000-08	开口挡圈	Snap Thrust Ring	1
24		21-06210101-01	垫圈	Washer	1
25		311.25-10	护针轴	Needle Guard Shaft	1
26		343.07-09	护针轴座组件	Bracket Asm.	1
		311.25-11	支架	Bracket	1
27		311.25-23	套筒	Copper Bushing	1
		12-60600420-01	螺钉	Screw	1
28		12-40400825-01	螺钉	Screw	3
29		343.07-12	护针曲柄	Needle Guard Crank	1
30		12-80500512-01	螺钉	Screw	1
31		343.07-14	护针曲柄滑套	Needle Guard Crank Slippery Set	1
32		12-40250425-01	前护针螺钉	Screw	1
33		301.07-21	前保针	Front Needle Guard	1
34		340.08-02	弯针	Looper	1
35		343.08-03	弯针曲柄	Looper Crank	1
36		343.08-26	偏心凸轮	Eccentricity Cam	1
37		343.08-27	弯针连杆组件	Looper Link Lever Asm.	1
		343.08-27-01	弯针连杆	Looper Link Lever	(1)
38		12-40401625-01	连杆螺钉	Link Lever Screw	(2)
39		12-80500612-01	凸轮螺钉	Cam Screw	3
40		343.09-38	牙架右限位板	Feed Rack Right Stopper Plate	1
41		301.09-15-02	针距调节套组件	Needle Distance Regulator Bushing Asm.	1
		301.09-15	针距调节套	Needle Distance Regulator Bushing	(1)
		340.09-15-02	定位螺钉	Screw	(1)
42		32-08440150-09	油封	Oilfelt	1
43		343.11-12	压紧杆套	Presser Bar Bushing	1

31. (500B-21)专用部件 SPECIFIC PARTS FOR (500B-21)

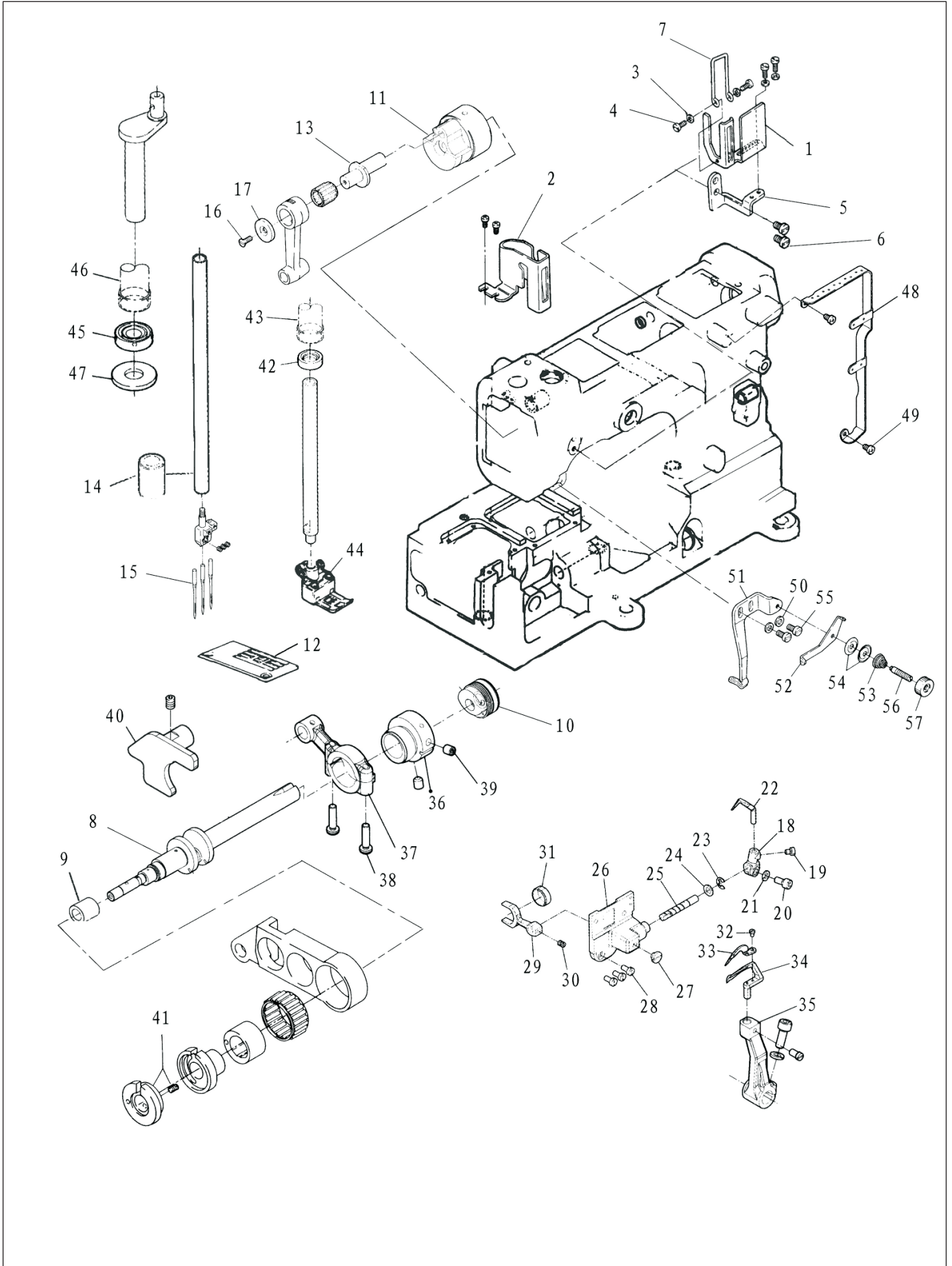

31. (500B-21)专用部件 SPECIFIC PARTS FOR (500B-21)

序号 NO.	注解 NOTE	图号 REF NO.	名称	DESCRIPTION	数量 AMT
44		340.11-38	压脚组件	Presser Foot Asm	1
		340.11-38-01	压脚扭簧（右）		(1)
		340.11-38-02	压脚		(1)
		340.11-38-03	压脚压簧		(1)
		340.11-38-04	压脚护板		(2)
		340.11-38-05	螺钉		(1)
		340.11-38-06	压脚滑板		(2)
		340.11-38-07	压脚柄		(1)
		340.11-38-08	压脚扭簧（右）		(1)
		340.11-38-09	圆柱销		(2)
		340.11-38-10	圆柱销		(1)
		340.11-38-11	螺钉		(1)
		340.11-38-12	螺钉		(1)
		340.11-38-13	螺钉		(1)
45		32-09440190-09	油封	Oilfelt	1
46		340.12-14	绷针轴竖套	Stretch Tight Needle Upright Bushing	1
47		21-10220232-03	垫圈	Washer	1
48		340.13-07	过线架	Thread Eyelet Stand	1
49		12-40400525-01	螺钉	Screw	2
50		21-04308090-02	垫圈	Washer	2
51		340.14-05	绷针线下过线板	Lower Thread Guide Plate	1
52		301.14-06	绷针过线板	Thread Guide Plate	1
53		209.19-13	压线簧	Presser Spring	1
54		209.19-12	过线压板	Presser Plate	2
55		12-40400825-01	螺钉	Screw	2
56		209.19-11	夹线螺钉	Screw	1
57		209.19-14	夹线螺母	Nut	1

32. (500A-01)专用部件 SPECIFIC PARTS(FOR 500A-01)

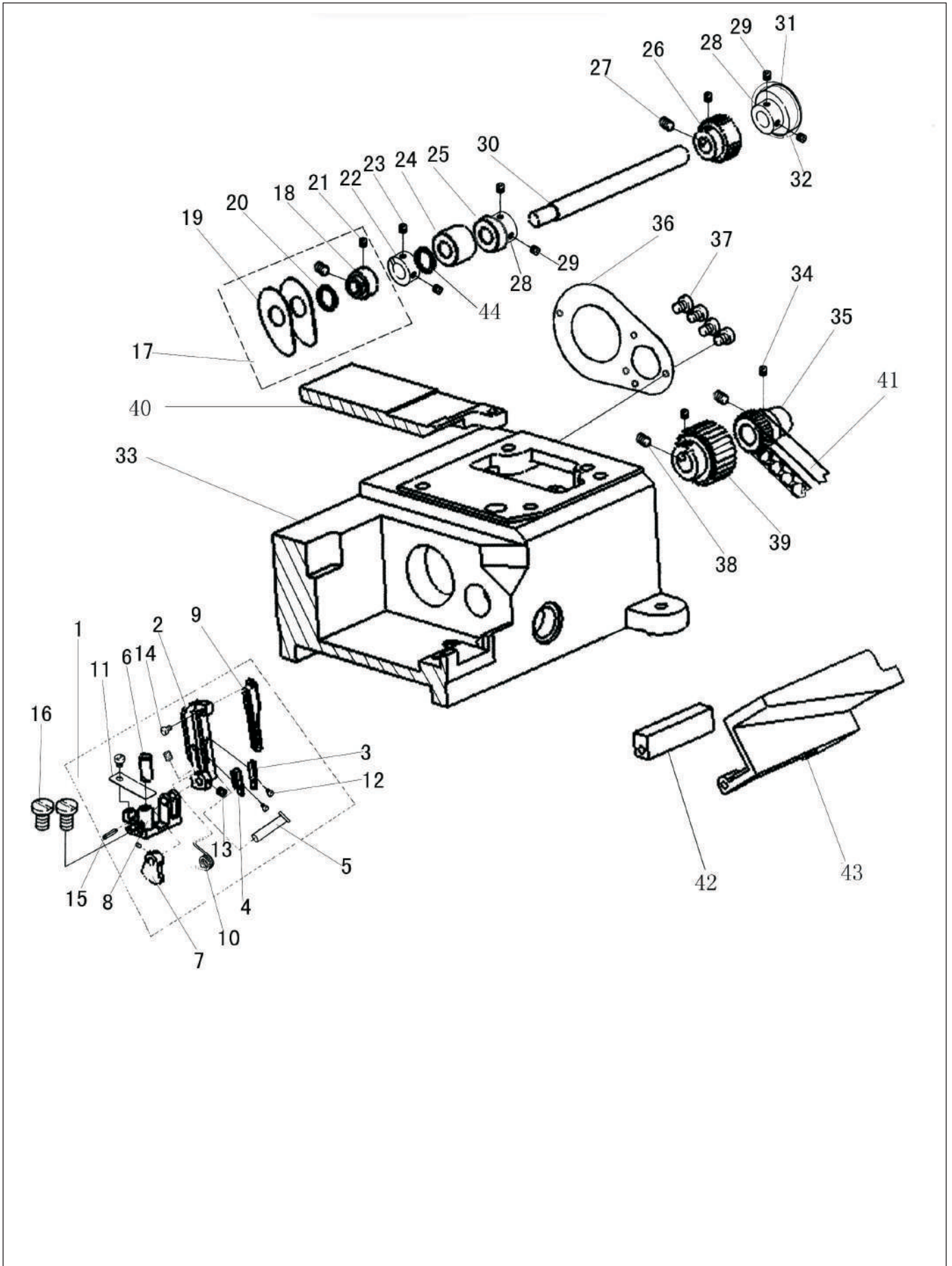

32. (500A-01)专用部件 SPECIFIC PARTS(FOR 500A-01)

序号 NO.	注解 NOTE	图号 REF NO.	名称	DESCRIPTION	数量 AMT
1		21-04308090-02	垫圈	Washer	1
2		301.18-02	硅油储盒盖	Silicone Oil Reservoir Cover	1
3		301.18-03	硅油储盒	Silicone Oil Reservoir	1
4		301.18-04	硅油盒油毡	Silicone Oil Reservoir Felt	1
5		301.18-05	硅油盒壳体	Silicone Oil Reservoir Body	1
6		42-07005000-00	硅油输油管	Silicone Oil Efferent	0.135
7		279.09-20	大头针	Pin	1
8		301.18-08	上硅油毡	Silicone Oil Felt (upper)	1
9		301.18-09	上硅油盖	Silicone Oil Cover (upper)	1
10		301.18-10	上硅油盒	Silicone Oil Case (upper)	1
11		41-20200500-00	开口弹簧销 $\phi 2 \times 5$	Elastic Pin $\phi 2 \times 16$	2
12		301.18-12	油线压板	Oil Wick Press Plate	1
13		43-10250000-00	油线	Oil Wick	0.27
14		301.16-19-01	弹簧管夹头(小)	Spring Tube Collet	2
15		12-40401025-01	螺钉	Screw	1
16		12-40400625-01	螺钉	Screw	1
17		12-40300625-01	螺钉	Screw	2
18		11-40090525-01	螺钉	Screw	2

GEMSY

© 2017 Copyright Zhejiang Shangong Gemsy Sewing Technology Co., Ltd

P/N. 1.17.02.07.031 Rev01-2017

AS58 Operation Panel (HMI) Instruction

1 Operation Panel Instruction

Operation Panel (See Fig1-1) is divided into two area: LCD display area and keys operation area.

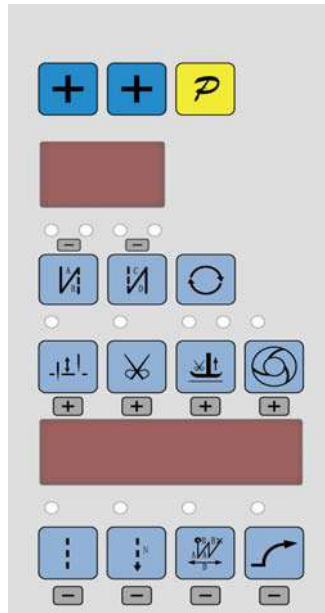















Fig.1-1

Digital display area is composed of 6 digital tubes, used to each parameter setting. There are 14 keys that used to display the key function open or not. Parts of keys have LED light. Table 1 shows function of each key.

Table 1: Following form is the instruction of each key:

No	Appearance	Description
1		Function key: Confirm working, or work with other key.
2		Cycle key: Switch parameter position when change parameter;
3		Plus key: Corresponds to the parameter addition 1
4		start back tacking key: Round with single start back tacking; double start back tacking; quad start back and close start back tacking. The 2 LED on the top of the key show current status.
5		end back tacking key: Round with single end back tacking; double end back tacking; quad end back tacking and close end back tacking. The 2 LED on the top of the key show current status.

6		Stop position key: Select up/down stop position/Increase thousand bit. The LED at top left corner of the key is lit if select up stop position.
7		Trimming key: Select/non-select automatic trimming/Increase hundred bit. The LED at top left corner of the key is lit if select automatic trimming.
8		Press foot lifting key: Set up automatic press foot lifting/Increase ten bit. Select press foot lifting and mid-press foot lifting. The 2 LED on the top of the key show current status.:
9		One-Shot-Sewing key: Select/non-select one-Shot-Sewing/ Increase Entries bit. The LED is lit at top left corner of the key when select one-Shot-Sewing.
10		Free sewing mode key: Select free sewing mode/ Decrease thousand bit. The LED is lit at top left corner of the key when working.
11		Multi-segment sewing mode key: Select multi-segment sewing mode/Decrease hundred bit. The LED is lit at top left corner of the key if working.
12		W sewing mode key: Select W sewing mode/Decrease ten bit. The LED is lit at top left corner of the key if working.
13		Soft start key: Select soft start function/Decrease Entries bit. The LED is lit at top left corner of the key if working.

2 Optional User Mode





2.1 Operator Mode



This mode is default mode of operation panel, operation panel enter this mode after it starts. Under this mode, the two connection decimal points will be lit from left to right in orderly during running, (LED

show as ) that means HMI is idle state.

Before performing any operation, if the long time does not press the key words, HMI will automatically switch to the idle state; the previous operations will not be executed.

2.1.1 Sewing Mode Setup:



Free sewing mode: Press  key, LED show as , if press  key, confirm the operation, digital tube display returned to the idle state, and the LED on the top left of the  key is lit.

Multi-segment sewing mode: Pres  key, digital tube display  is

multi-segment sewing status. With  (9、13、8、12) four keys to set Multi-segment sewing

mode (The highest 24 segment), then press  key to entry multi-segment sewing stitch number of each



segment setup status and digital tube display .



With  (3、4、6、10) four keys to modify segment index, with  (9、

13、8、12) four keys to modify multi-segment sewing stitch number of each segment. If press  key to

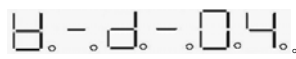
confirm working, the digital tube is lit and display idle state. The LED at top left corner of the  key is lit if open multi-segment sewing mode.



W sewing mode : Press  key, 8-segment LED will display W sewing status,



. Press  (6、10) key can be used to choose A B D segment, and

use  (9、13、8、12) to modify stitches of each segment. After confirmation, press  key,

8-segment LED display will come back to idle, and LED on the top left side of  key will be lit.

2.1.2 start/end back tacking setup:

If press 4  key or 5  key, 8-segment LED will display start back tacking status or end back tacking status.



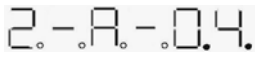

If press 4  key, it actives single start back tacking ,





tacking , quad start back , close start back

tacking .

If press 5  key , it actives single end back tacking, double end back tacking, quad end back, close



end back tacking (Fig omit) .Press  (6、10) key to choice A、 B or C、 D segment, and

use    (9、13、8、12) to choice stitches of each segment. After confirmation, press  key, LCD display will come back to idle, and two Leds on start back tacking key and end back tacking key will light to show the status accordingly.

- ◆ When two LED on  key switch off, it means no back tacking;
- ◆ When LED on top left of  key is on, and on top right off, it means single back tacking;
- ◆ When LED on top left of  key is off, and on top right light, it means double back tacking;
- ◆ When the two LED on  key are all lit, it means quad back tacking;



Note: We supply only start back tacking, same with end back tacking key



2.1.3 Soft start setup:

Press soft 13  key, entry into soft start status, the  key of LED on top left will be lit active. Press

this key again to exit soft start status, the  key of LED on top left will be off.

2.1.4 Press foot lifting key:

Use 8  key : select foot lifting status, there are four different status, no automatic foot lifting, as ;

automatic foot lifting after trimming, as ; automatic foot lifting if stop during sewing, as ; automatic

foot lifting if trimming and stop during sewing, as . Use  key to choice and LED on the top will show the status accordingly.



2.1.5 Trimming key:

Use  key: select/non-select automatic trimming. LED on top left side of the trimming key will be lit if

automatic trimming is selected, as , otherwise, LED off, as .



2.1.6 One-Shot-Sewing key

Use  key: select/non-select one-shot-sewing. LED on top left side of the one-shot-sewing key will be

lit if one-shot-sewing is selected during enable multi-segment, as ; otherwise, LED off, as .



2.1.7 Stop position key

Use  key: select up/down stop position. LED on top left side of this key will be lit if select down



needle position, as ; LED off if select up needle position, as .



2.2 Technician Mode

In this mode, technical parameters corresponding to various functions can be adjusted or reset according to practical needs so that the system may run in the best condition. Parameters setting under technician mode:

Step 1: Under operator mode, press  key and  key, the LCD will display Pd - 0000, and then set the password by technician. The default password is 0000, and LCD display

as .

Step 2: Use  (6-13) keys to input the password, and then press  key. If the password is correct then enter technician mode, otherwise, it will return to operator mode.

Step 3: Change technician parameters by  (4, 5) keys and  key. The parameters are shown in table 2.

Step 4: Parameters values can be changed by  (6-13) keys.

Step 5: Under technician mode, press  key, the panel will return to operator mode.

Table 2: Technician mode parameter:

	Parameter High byte	Parameter Low byte	Default	Rang	Comment
speed	0	0	200	100~800	Minimum sewing speed
		1	3500	200~5000	Maximum sewing speed
		2	3000	200~5000	Maximum constant sewing speed
		3	3000	200~5000	Maximum manual back tacking speed
		4	200	100~800	Stitch compensation speed
		5	250	100~500	Trimming speed
		6	0	0 / 1	Soft start Mode setup: 0: Soft start only after trimming 1: Soft start after both trimming and stop
		7	2	1~9	Soft start stitch number
		8	200	100~800	Soft start speed
		9	13	1~20	System accelerate sensitivity (Direct drive transmission can be set up to a large value; belt transmission don't set large value or too much noise and vibration. This parameter do not affect the electrical)
		A	13	1~20	System decelerate sensitivity (Direct drive transmission can be set up to a large value; belt transmission don't set large value or too much noise and vibration. This parameter do not affect the electrical)
Back tacking setup	1	0	1800	200~3000	Start back tacking speed
		1	1800	200~3000	End back tacking speed
		2	1800	200~3000	Continuous back tacking speed
		3	26	0~70	Start back tacking stitch compensation 1
		4	20	0~70	Start back tacking stitch compensation 2
		5	26	0~70	End back tracking stitch compensation 1
		6	20	0~70	End back tracking stitch compensation 2

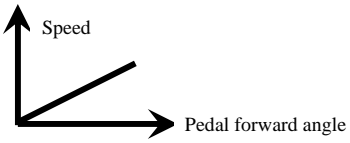
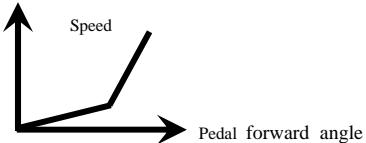
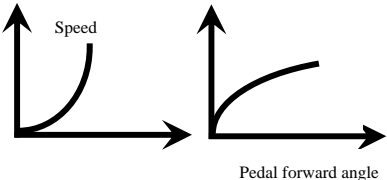
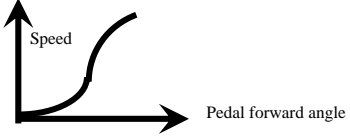
	Parameter High byte	Parameter Low byte	Default	Rang	Comment
Pedal	3	0	0	0/1/2/3	Pedal Curve mode setup: 0: Auto Calculated liner Curve (According to the highest speed automatic computation) 
					1: Two segment liner Curve. (You shall be free to set slow start after fast or fast start after slow, the parameters "31" and "32" cooperate with use) 
					2: Arithmetic Curve (the parameters [33] cooperate with use) 
					3: S curve (the operate control is very well, slow start after fast) 

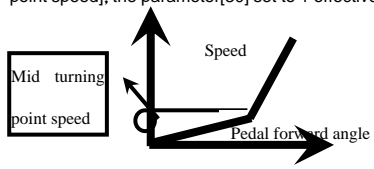
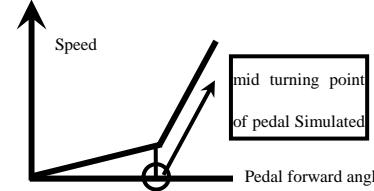
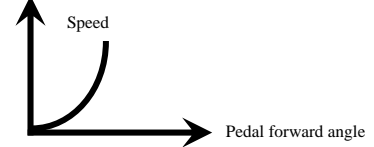
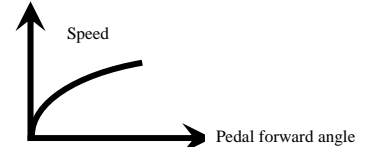
	Parameter High byte	Parameter Low byte	Default	Rang	Comment
		1	3000	200~4000	<p>Two segment controls the speed slope : mid turning point speed RPM(two segment of turning point speed), the parameter[30] set to 1 effective.</p> 
		2	800	0~1024	<p>Two segment controls the speed slope : mid turning point of pedal Simulated value, the parameter[30] set to 1 effective, the value is between[38]and[39].</p> 
		3	1	1~2	<p>Arithmetic Curve supplementary parameter : the parameter[30] set to 2 effective,</p> <p>1: Square (the low speed control is very well, slow start after fast) ;</p>  <p>2: Square root (Responding speed is fast, fast start after slow) ;</p> 

	Parameter High byte	Parameter Low byte	Default	Rang	Comment
		4	90	0 ~ 1024	Pedal trimming position set, See 2-1. (the value is not higher than the parameter [30])
		5	300	0 ~ 1024	Press foot lifting, See 2-1. (the value is between[34]and[36].)
		6	460	0 ~ 1024	Pedal back mid position, see 2-1. (the value is between[35]and[37].)
		7	480	0 ~ 1024	Pedal step upon running position, see 2-1. (the value is between[36]and[38])
		8	680	0 ~ 1024	Pedal low speed running position (upper), see 2-1 (the value is between[37]and[39])
		9	960	0 ~ 1024	Pedal simulation the largest of value, see 2-1 (the value is not lower than the parameter [38])
		A	100	0 ~ 800	Pedal press foot lifting confirm time
custom setup	4	0	1	0 / 1	Run to up needle position after Power on: 0: no action 1: action
		1	1	0 / 1	Automatically reinforcing functions chose : (the machine head is not automatically reinforcing functions, the best way is prohibit) 0: prohibit 1: allow
		2	0	0 / 1	Back to sewing by hand when the function mode selection: 0: Juki mode. In sewing or in the end of the action 1: Brother mode. It acts only in sewing.
		3	0	0 / 1 / 2 / 3	Special Running Mode setup: 0: operator select 1: simple sewing mode 2: calculate initial angle of motor (do not uninstall strap) 3: calculate motor/machine head run rate mode (synchronizer, do not uninstall strap)

	Parameter High byte	Parameter Low byte	Default	Rang	Comment
		4	0	0-31	Torque boost up at low speed : 0: no action 1-31: 31 levels Torque boost up
		5	1	0 / 1	Stop pin mode : 0: Constant speed tackle mode (in the belt transmission, Parking is not precision) 1: back pull mode (PMX)
		6	150	0-800	Command button to fill half-needle time
		7	180	0-800	Command button to fill a needle time
Operation	6	1	0	0 / 1 / 2	Translating Parameter 0: no action 1: Download parameters(the panel will parameter from panel to controller) 2: Upload parameters (the panel will parameter from controller to panel)
		2	0	1, 2, XXXX	Restore storage parameter(Only restore parameters to operators, and vendors and maintenance) Belt flat 1000/ Direct drive flat 2000
		3	0	1, 2	Backup current parameter as user parameter for restore (restore)
		Note: Above such "6x "parameter to operate is not saved.			

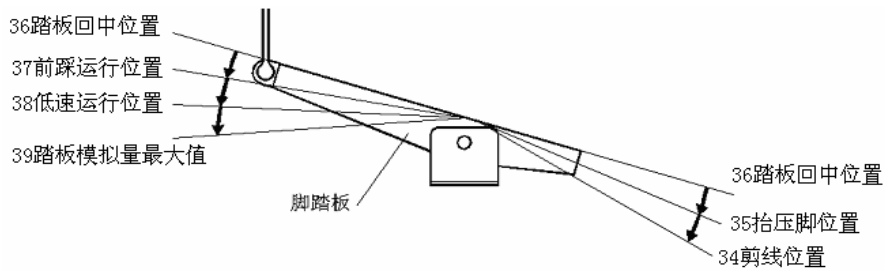





Fig2-1 Pedal action parameter the position of the diagram



2.3 Administrator Mode

In this mode, various solenoid parameters set can be regulated according to the practical need so that the servo system can normally run on every sewing machine. Parameters setting under technician mode:

Step 1: Under operator mode, press  and  keys to enter administrator mode in LCD Pd-0000,

The default password is 0000, and LCD display as .

Step 2: The password is entered using  (6-13) keys, then press  key. If the password is correct, enter into the technician mode, or return to the operator mode.

Step 3: Change administrator parameters index by  (4、5) keys and  keys under administrator mode. The details of technician parameters are shown in table3.

Step 4: Parameters values can be changed by  (6-13) keys.

Step 5: Under administrator mode, press  key, the panel will return to operator mode.



Table 3: Administrator mode parameter:



	Parameter High byte	Parameter Low byte	Default	Rang	Comment
Trimming mode	0	2	1	0 / 1 / 2 / 3	Mode selection for trimming sequence. 0: According to the parameters 【03】 set angles is trimming, until up position delayed 【06】 time off. 1: According to the parameters 【03】 set angles is trimming, until 【04】 set angles off. 2: According to the parameters 【03】 set angles is trimming, it delayed 【06】 off. 3: Down position signal delayed the parameter【05】 set angles is trimming, it delayed 【06】 off.
		3	10	5-359	The start angles of trimming (relative down position of angle)



	Parameter High byte	Parameter Low byte	Default	Rang	Comment
		4	180	10-359	The end angles of trimming (relative down position of angle, Need to greater than the system of parameters 【03】)
		5	10	1-999	Trimming start delay time T1 (ms)
		6	60	1-999	Trimming end delay time T2 (ms)
Tension release 、 Wiper and Clamp mode	1	0	0	0 / 1 / 2 / 3 / 4	Mode selection for tension-release sequence: 0:According to the parameters [11] set angles is tension release, until up position delayed [14] time off. 1: According to the parameters 【11】 set angles is tension release, until 【12】 set angles off. 2: According to the parameters 【11】 set angles is tension release, it delayed 【14】 off. 3:Down position signal delayed the parameter【13】 set angles is trimming, it delayed 【14】 off. 4: Up position signal delayed the parameter 【13】 set angles is trimming, it delayed 【14】 off.
		1	25	5-359	The start angles of tension release(relative down position of angle)
		2	300	10-359	The end angles of tension release (relative down position of angle, Need to greater than the system of parameters 【11】)
		3	1	1-999	Tension release solenoid start delay timeT1 (ms)
		4	10	1-999	Tension release solenoid up position delay time T2 (ms)
		5	1	0 / 1	selection for Wiper function 0: off 1: on
		6	10	1-999	Clamp /Wiper delay time ms
		7	30	1-9999	Clamp /Wiper holding time ms

	Parameter High byte	Parameter Low byte	Default	Rang	Comment
		8	50	1-999	Clamp /Wiper revert time ms
		9	0	0 / 1	Thread Clamp function : 0: off 1: on
		A	100	0-359	Clamp start angle
		b	210	0-359	Clamp end angle
Stop mode	3	1	0	0 / 1	The automatic test mode selection : 0: order stitches 1: order time
		2	300	0-1000	The safety SW alarm confirm time ms(the same way does not distinguish between direct-drive safety SW and flat lock trim of protection SW)
		3	50	0-1000	The safety SW restore confirm time ms
		4	0	0 / 1	Motor rotation direction setup: 1: Forward 0: Reverse
Machine head parameter	4	0	1000	0-9999	motor/machine head run rate: 0.001 (if automatic calculation of motor/machine head run rate has done, the Parameter value in control box maybe different with that in HMI)
		2	0	0-359	Up needle position adjusted angle (compare to up position sensor position excursion)
		3	175	0-359	Down needle position mechanical angle
		4	1	1-800	Press down delay time(ms)

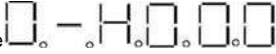
2.4 HMI version number and its parameter modified mode

During HMI idle, Press  key, then press  key, HMI entry display version number interface, such

as see picture . HMI return to idle if press  or no press the key after regulate time.

After HMI entry display version number interface, if press  key, then press  key, HMI can entry







itself parameter modification interface, and show as . It can be used to modify the parameter index and the setting value, through the number corresponding to the up and down keys. In determining the parameters according to press  key to determining modification. HMI back to idle if no press the key after regulate time.

Table 2: HMI parameter

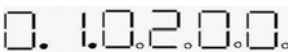
Parameter index number	NOTE
01	retain
02	retain
03	retain
04	retain
05	retain
06	In any condition, if the custom is not to press the button in a specified period of time , it will automatically exit to the HMI idle state, parameter index 06 regulation of waiting time. Adjustment range 2 ~ 10.
07	retain

2.5 Monitor mode

During HMI idle, Press  key, then press  key, entry monitor mode. Use   (4、5) keys and

 keys to switch to watch the parameters. About the monitor parameter, please refer the sheet 5, HMI will back to idle if no operation after regulates time.

Table 5: monitor mode parameter

	Parameter High byte	Parameter Low byte	unit	comment
Monitor status	1	0		Counter stitches
		1		Counter trimming
	2	0	V	DC Bus Voltage
		1	RPM	Motor speed
		2	0.01A	One phase current
		3	degree	Initial angle

		4	degree	Mechanical angle
		5	—	Sampling value of pedal voltage
		6	0.001	motor/machine head run ratio
		7	hour	Motor total run time
		8	—	Sampling value of potentiometer at machine head
	3	0-7	—	History Error Code Recorder 8

2.6 Wrong warning mode

If the HMI detects something wrong from controller, it will jump automatically to warning mode, and

show error code see . During wrong warning mode, the user can set technician parameter change, administrator parameter and HMI parameter self-change or monitor mode. Exit these modes not back to idle but back to wrong warning mode. It will return normal status after fixing error and resetting power.



2.7 The external panel insert mode



When the external HMI is inserted, this HMI will stop work and the digital tube and all LED are lit.



When the external panel is pulled out, after about 2 seconds, the panel restores to work.

3 Control system restores storage parameter



3.1 Restore storage parameter for factory of control

Step 1: Under operator mode, press  and  keys, LCD Pd-0000; user require to type the passport.

Step 2: The password is entered using  (6-13) keys, then press  key. If the password is correct, enter into the technician mode, or return to the operator mode.



Step 3: Change administrator parameters index to【62】by   (4、5)keys and  keys under technician mode. Restore storage parameter for factory of control can be changed by



 (6-13) keys, usually there are four valid bit.



Step 4: the parameter confirms correct, press  key until the LED start flashing, release  key, HMI and the whole system restore storage parameter.

3.2 Restore default user's own parameter

The parameter **【63】** of HMI can be used to set the customer's own parameters, following methods of operation :

Step 1: Under operator mode, press  and  keys, LCD **Pd-0000**; user require to type the passport.

Step 2: The password is entered using  (6-13) keys, then press  key. If the password is correct, enter into the technician mode, or return to the operator mode.

Step 3: Change administrator parameters index to **【62】** by  (4、5) keys and  keys under technician mode. The value is changed 1 or 2 by  (9、13)keys.

Note: If it set 1, when you want to restore the parameter, enter into index **【62】** and set the parameter 1; when set 2, the parameter enter into index **【62】**, set 2.

Step 4: Press  key keep 5 second, HMI and the whole system will the current parameter set restore the user to customize storage parameter.

When the parameter cause to the control system error, the user can restore the custom of the parameters, the methods of operation as "4.1 Restore storage parameter for factory of control" .The parameter **【62】** is changed 1 or 2, Press  key keep 5 second again, the system will restore the user to customize storage parameter.

Note:

- 1、 After power on, HMI only download **operator mode** parameter, but not **technician** and **administrator** parameter. If all parameter is needed, **technician** parameter 61 can used to download all current working parameter of HMI 50.
- 2、 If restore other parameter of HMI storage, **technician** 62 can be used to make it current working parameter, and download initiative.
- 3、 After single parameter modification, HMI will download the value that is different with old value of parameter.
- 4、 Recover default parameters, the system the best in the clear once again.

386P00480

2011-11-8

A 版



ASE5A

工业缝纫机伺服控制器

Industrial Sewing Machine Servo controller

使用说明书

User manual

目 录

1 产品安装.....	1
1.1 产品规格	1
1.2 接口插头的连接.....	1
1.3 连线与接地.....	2
2 操作面板使用说明	3
2.1 操作面板的显示说明.....	3
2.2 操作面板各按键功能说明	4
3 系统参数设置说明	6
3.1 参数模式	6
3.2 监控参数表操	11
3.3 全报警.....	11
3.4 障代码表	11
4 特殊功能操作说明	13
4.1 上停针位调整	13
4.2 一键恢复机头厂家参数值	13
4.3 脚踏板灵敏度调整	14

前言

 注意	<p>使用前请仔细阅读本用户手册及所搭配的设备说明书，配合正确使用，并由接受过专业培训的人员来安装或操作。</p>
--	---

本产品仅适用于指定范围的设备，请勿移做其他用途。

使用中若存有任何疑问或对我们的产品及服务有任何意见或建议，请随时与我们联系

安全事项

- 在使用本产品之前，请先阅读《产品说明书》及所搭配的缝纫机机械说明书。
- 本产品必须由接受过专业培训的人员来安装或操作。
- 请尽量远离电弧焊接设备，以免产生的电磁波干扰本控制器而发生误动作。
- 请不要在室温 45° 以上或者 0° 以下的场所使用。
- 请不要在湿度 30%以下或者 95%以上或者有露水和酸雾的场所使用。
- 安装控制箱及其他部件时，请先关闭电源并拔掉电源插头。
- 为防止干扰或漏电事故，请做好接地工程，电源线的接地线必须牢固的方式与大地有效连接。
- 所有维修用的零部件，须由本公司提供或认可，方可使用。
- 在进行任何保养维修动作前，必须关闭电源并拔掉电源插头。控制箱里有高压危险，必须关闭电源五分钟后方可打开控制箱。
- 本手册中标有  符号之处为安全注意点，必须注意并严格遵守，以免造成不必要的损害。

1 产品安装

1.1 产品规格

产品型号	AHE5A	电源电压	AC 220 ± 20% V
电源频率	50Hz/60Hz	最大输出功率	550W

1.2 接口插头的连接

将脚踏板及机头的各连接插头安插到控制器后面对应的插座上，各插座名称如图 1-2 所示。连接好，请检查插头是否插牢。



图 1-1 AS 系列控制器图

①机头灯；② 脚踏板；



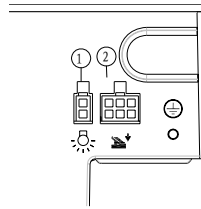

图 1-2 控制器接口定义

1.3 连线与接地

必须要做好系统的接地工程，请合格的电气工程人员予以施工。产品通电及投入使用前，必须确保电源插座 AC 输入端已安全可靠的接地。系统的接地线为黄绿线，该地线请务必可靠连接至电网安全保护接地上，以保证安全使用，并可防止出现异常情况。

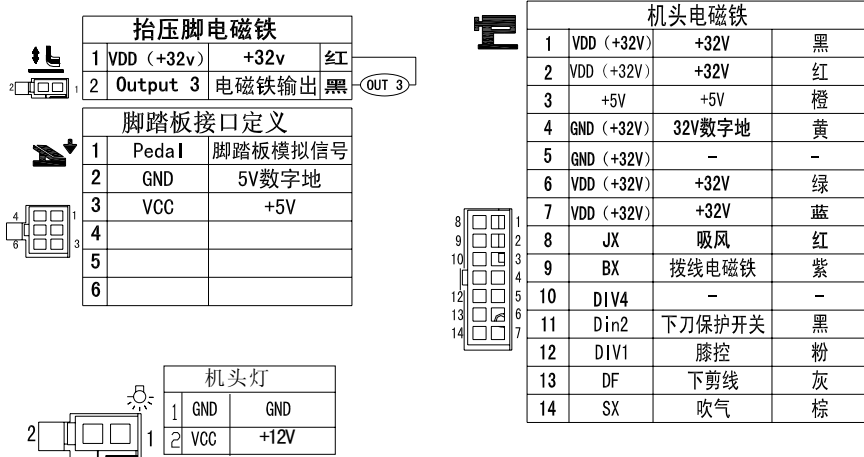
 所有电源线、信号线、接地线等接线时不要被其它物体压到或过度扭曲，以确保使用安全！

2 操作面板使用说明

2.1 操作面板的显示说明

根据系统工作状态，操作面板的液晶屏模块将显示当前的缝纫模式、各种参数、前/后固缝设置，以及抬压脚、停针位、剪线、慢速起缝等液晶字符。操作面板液晶屏功能图标显示说明如图 2-2 所示。



图 2-1 操作面板外观界面







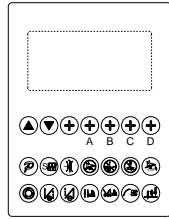

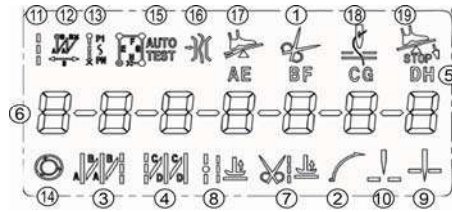

图 2-2 操作面板液晶显示屏图示

表 2-1 操作面板液晶功能图标显示说明

索引	图标	描述
①		自动剪线功能
②		软启动功能
③		前加固缝
④		后加固缝
⑤		缝纫段数标记
⑥		计数/参数值显示
⑦		剪线后抬压脚
⑧		中间停针抬压脚
⑨		中间停针下停针
⑩		中间停针上停针
⑪		自由缝
⑫		W 缝
⑬		多段缝
⑭		多段缝触发功能
⑮		自动测试
⑯		夹线功能
⑰		后半踏功能
⑱		扫线功能
⑲		起始定针缝

2.2 操作面板各按键功能说明

表 2-2 每个按键功能介绍

序号	外观	名称	功能描述
1		参数进入 及返回键	一般模式下，按此键进入参数模式。参数模式下，按此键不保存修改，返回一般模式。此外，还可与其它按键同时按下实现组合功能。
2		模式切换 及修改保 存键	一般模式界面下按下此按键，循环切换自由缝、W 缝、多段缝。参数模式下，修改参数后，按此键，保存参数，再按一次，返回一般模式。
3		前加固缝 键	系统为平缝参数时，作为起始倒针功能选择键，每按动一次，系统前固缝工作模式将按照 11B 号参数设置在无前固缝与前单固缝、前双固缝、前四固缝之间循环选择，对应液晶屏图标点亮。同时显示即为前固缝界面，选择对应的 \oplus 键和 \oplus 键可增减设置 A、B 段的针数，默认针数范围 0~F 对应 0~15 针。绷缝模式下此按键不能设置起始倒针功能。参数界面，按动一次，参数号加 1。
4		后加固缝 键	系统为平缝参数时，作为结束倒针功能选择键，每按动一次，系统后固缝工作模式将按照 11B 号参数设置在无后固缝与后单固缝、后双固缝、后四固缝之间循环选择，对应液晶屏图标点亮。同时显示即为后固缝界面，选择对应的 \oplus 键和 \oplus 键可增减设置 C、D 段的针数，默认针数范围 0~F 对应 0~15 针。绷缝模式下此按键不能设置结束倒针功能。参数界面，按动一次，参数号减 1。
5		夹线键	按下该键，液晶屏图标 --- 亮，表明夹线功能有效，再按一下该图标熄灭，表明关闭夹线功能。
6		多段缝 触发键	在多段缝模式下，按下该键，液晶屏图标 --- 点亮，表明选择触发模式有效，此时点动脚踏板一次即可完成当前段的设定针数缝制；再按一下该图标熄灭，表明多段缝下触发功能关闭。
7		中间抬 压脚键	按下该键，液晶图标 --- 点亮，表明缝绉中停车自动抬压脚有效，再按一下该图标熄灭，表明关闭缝绉中停车自动抬压脚功能。

序号	外观	名称	功能描述
8		剪线抬压脚键	按下该键，液晶图标  点亮，表明剪线后自动抬压脚有效，再按一下该图标熄灭，表明关闭剪线后自动抬压脚功能。
9		软启动键 /LED灯	按下该键，液晶屏图标  点亮，表明软启动有效，再按一下该图标熄灭，表明关闭软启动功能。长按此键，可调 LED 灯三档亮度。
10		停针位键	用于缝纫中途停车时系统的上/下停针位置选择，按下该键，  点亮，表明为上停针，再按下该键，  点亮，表明为下停针。但缝纫完成剪线之后，系统将停车在上针位。
11		速度增减键	可快捷设置临时调速。在多段缝模式下。此外，在参数设置时，单按此按键，对应参数号的加。  +此按键，作为对应参数号的减。
12		参数增加键	调整对应数值的增加键。  +此按键作为对应数值的减小键。
13		自动剪线键	按下该键，液晶屏图标  熄灭，表明自动剪线功能无效，再按一下该图标被点亮，表明开启剪线功能。
14		半后踏键	按下该键，液晶图标  熄灭，表明半后踏功能无效，再按一下该图标被点亮，表明开启半后踏功能。
15		扫线键	按下该键，液晶图标  熄灭，表明扫线功能无效，再按一下该图标被点亮，表明开启扫线功能。
16		起始定针缝	按下该键，液晶图标  点亮，表明起始定针缝功能有效，再按一下该图标熄灭，表明关闭起始定针缝功能。

3 系统参数设置说明

3.1 参数模式

- 1、 待机状态，按 P 键即可进入参数模式；
- 2、 按对应 \blacktriangle \blacktriangledown 键和 \oplus 键，可增加参数号及增加参数值。按 $\text{P}+\blacktriangle$ $\text{P}+\blacktriangledown$ 和 $\text{P}+\oplus$ 键，可减小参数号及减小参数值；
- 3、 按前加固缝 L 键和后加固缝 R 键可加减本段参数索引号；
- 4、 当参数值有加减，参数界面闪烁。此时，按 S 键，保存修改，界面不再闪烁。再按 S 键退出参数界面，返回一般模式；
- 5、 参数模式下，按 P 键，修改值不保存，待机状态。

参数编号	参数范围	典型值	参数描述	备注
100	100-800	200	起缝速度	速度
101	200-5000	3500	自由缝最高速（全局最高限速）	
102	200-5000	3000	定长缝最高速	
103	200-5000	3000	手动倒缝最高限速	
104	100-800	200	补针速度	
105	100-500	250	剪线速度	
106	0 / 1	0	慢速启动模式 0: 仅剪线后有慢速启动； 1: 剪线后、中间停止都有慢速启动	
107	1-9	2	慢速起缝针数	
108	100-800	200	慢速起缝速度	加固 缝参数
115	1-70	24	后固缝针迹补偿 1（吸合补偿，数值增大表示加快吸合）	
116	1-70	20	后固缝针迹补偿 2（释放补偿，数值增大表示释放加快）	踏板 参数
130	0 / 1 / 2 / 3	2	脚踏板曲线模式： 0: 自动线性斜率（根据最高速自动计算） 1: 两段斜率； 2: 幂次曲线； 3: S 型曲线	
131	200-4000	3000	两段斜率：中段速度 RPM（两段斜率的转折点速度）	
132	0~1024	800	两段斜率：中段踏板模拟量（需在 138 到 139 参数之间）	

133	1/2	1	幂次曲线： 1: 平方曲线； 2: 开方曲线；	
134	0~1024	90	踏板剪线位置	具体设置方法见图 4-1 所示。
135	0~1024	300	踏板抬压脚位置	
136	0~1024	460	踏板回中位置	
137	0~1024	480	踏板前踩运行位置	
138	0~1024	580	踏板低速运行位置（上限）	
139	0~1024	962	踏板模拟量最大值	
13E	1~800	100	剪线后抬压脚延迟时间（拨线）	
140	0/1	1	上电自动找上针位： 0 不找；1 找	习惯 设定
143	0/1/2/ 3	0	特殊运行模式： 0: 操作工选择（正常） 1: 简易缝模式 2: 测电机初始角（不需要取下皮带） 3: 计算传动比模式（需要有停针传感器，且不能取下皮带）	
144	0~31	0	电机低速加力功能开关： 0 正常功能； 1~31: 低速加力过厚能力档位	
149	0~10	0	缓放压脚斩波开通时间(100us 单位)	
150	1~100	1	计针数功能比例值设定	计数 模式
151	1~9999	1	计针数上限设定值	
152	0~6	0	计针数模式选择： 0: 不计数 1: 依针数递增计数，计数满后自动重新计数 2: 依针数递减计数，计数满后自动重新计数 3: 依针数递增计数，计数满后马达自动停止，须由复位按钮设定或面板上的 P 键来启动重新计数。 4: 依针数递减计数，计数满后马达自动停止，须由复位按钮设定或面板上的 P 键来启动重新计数。 5: 依针数递增计数，计数满后发出报警，剪线后马达锁住 6: 依针数递减计数，计数满后发出报警，剪线后马达锁住	

153	1~100	1	计件数功能比例值设定	计数模式
154	1~9999	1	计件数上限设定值	
155	0~4	0	计件数模式选择: 0: 不计数 1: 计件数递增计数, 计数满后自动重新计数 2: 计件数递减计数, 计数满后自动重新计数 3: 计件数递增计数, 计数满后马达自动停止, 须由复位按钮设定或面板上的 P 键来启动重新计数。 4: 计件数递减计数, 计数满后马达自动停止, 须由复位按钮设定或面板上的 P 键来启动重新计数。	
156	0~9999	0	对应 1/2/3/4 号电磁铁斩波占空比时间选择(0 以 ms 为单位, 1 以 0.1ms 为单位)	
157	0~9999	0	对应 5/6/7/8 号电磁铁斩波占空比时间选择(0 以 ms 为单位, 1 以 0.1ms 为单位)	
158	0~1	0	计数可调开关 (计针数和计件数) (0 可调, 1 不可调)	
160		0	运行时间复位	
161	0/1/2		参数传输: 0: 无动作; 1: 下传参数; 2: 上传参数	
165	-		恢复控制器出厂参数, 并覆盖机头厂参数或用户自定义机修参数, 原有参数不可恢复。	
200	0/1/2	0	剪线电机运行模式选择: 0: 平车式; 1: 绷缝式 (普通绷缝剪线: 停到上针位后剪线);	

202	0 / 1 / 2 / 3 / 4 / 5 / 6	1	<p>剪线时序选择:</p> <p>0: 203 号参数所设定角度[TS]处进行切线, 直至上停针后延时 206 参数所设定时间[T2]为止。</p> <p>1: 203 号参数所设定角度[TS]处进行切线, 直至 204 号参数所设定角度[TE]为止。</p> <p>2: 203 号参数所设定角度[TS]处进行切线, 延时 206 参数所设定时间[T2]为止。</p> <p>3: 下针位信号后延迟 205 号参数所设定时间[T1]进行切线, 延时 206 参数所设定时间[T2]设定时间为止。</p> <p>4: 找到上针位信号后延迟 205 号参数所设定时间[T1]进行切线, 延时 206 参数所设定时间[T2]设定时间为止, 大部分应用于绷缝机。</p> <p>5: 找到下针位信号后即开始进行切线动作至上停针止。然后延迟 205 号参数所设定时间[T1]后再作 206 参数所设定的切线时间[T2]。(大部分用于一般平车机型, 而 T1 与 T2 设定值大部分均设为 0)</p> <p>6: 203 号参数所设定角度[TS]处进行切线东芝至上停针止。然后延迟 205 号参数所设定时间[T1]后再作 206 参数所设定的切线时间[T2]。</p>	剪线模式
203	5-359	10	剪线开始角度 TS (相对于下针位角度) (平车)	
204	10-359	120	剪线结束角度 TE (相对于下针位角度, 需大于 TS) (平车)	
205	1-999	10	剪线开始延时 T1 (ms) (绷缝)	
206	1-999	120	剪线结束延时 T2 (ms) (绷缝)	
211	5-359	25	松线电磁铁启动角度 LS (相对于下针位角度)	松线, 扫线, 夹线模式
212	10-359	350	松线电磁铁结束角度 LE (相对于下针位角度, 需大于 LS)	
213	1-999	1	松线电磁铁启动延迟时间 L1 (ms)	
214	1~999	10	松线电磁铁上针位后延迟时间 L2 (ms)	
216	1~999	10	拨线 / 扫线延迟时间 ms	
217	1~9999	70	拨线 / 扫线持续时间 ms	
218	1~999	50	拨线 / 扫线复原时间 ms	

21C	0~9999	0	吹风开始延时 ms	
21d	1~9999	50	吹风持续时间 ms	
21E	11-359	160	夹线时压脚抬起后的下放角度	
220	200~360	360	剪线后停止位置 (可实现剪线回拉功能)	停止模式
221	0~240	0	缝纫前反转角度 (提高过厚料能力)	
224	0/1/2/3	0	紧急停车模式: 0: 关闭紧急停车功能 1: 紧急停于任何位置 2: 紧急停于上针位 3: 紧急停于下针位	
225	0~999	0	紧急停车前继续缝纫的针数 (根据速度与针数设定不同, 实际可能大于此数量)	
226	0/1	0	紧急停车后再启动: 0: 不可再启动, 需重新上电; 1: 信号撤销后可再次开始缝纫	
227	200~360	360	中间停下针位位置调整	
231	0/1	0	自动测试模式选择: (前面两位数模式设置) 0: 定针数; 1: 定时间 (×100ms)	
232	0~1000	300	安全开关报警确认时间 ms (不区分直驱翻台开关和绷缝剪刀保护开关, 统一处理方式)	
233	0~1000	50	安全开关恢复确认时间 ms	
234	0/1	0	电机转向: 0: 正转; 1: 反转	
240	0~9999	1000	电机/机头传动比: X0.001 (如果自动计算过传动比, 控制器内的该参数可能与 HMI 上的不同)	机头相关参数
242	0~359	0	上停针位调整角度 (相对于上针位传感器的位置偏移)	
243	0~359	175	下停针位机械角度	
244	0~800	200	放压脚延迟时间 (ms)	

247	0~2000	0	加油提醒时间(小时) 0: 关闭此功能
248	0~4000	0	加油报警、禁止运行时间(小时) 0: 关闭此功能

3.2 监控参数表

参数编号	参数描述	参数编号	参数描述
010	针数计数	026	机头传动比实际值
011	计件数	027	电机累计运行时间(Hour)
012	机头真实速度	028	机头交互量电压采样值
013	霍尔状态	029	DSP 软件版本号
020	母线电压	02A	模拟输入 1 采样值
021	机头速度	02b	模拟输入 2 采样值
022	相电流	02C	错误计数器
023	初始角度	02d	QP 超状态
024	机械角度	030-037	历史故障代码
025	踏板电压采样值		

3.3 安全报警

报警代码	代码含义	解决措施
ALA-1	加油提醒	按 P 键可暂时取消报警。请及时加油
ALA-2	计针数报警	表示计针数已达所设上限, 按 P 键可取消报警并重新计数
ALA-3	计件数报警	表示计件数已达所设上限, 按 P 键可取消报警并重新计数
ALA-4	紧急停车	再按下紧急停车按钮, 可消除紧急停车状态
ALA-5	提针锁定	再按下提针锁定按钮, 可消除提针锁定状态
POH0FF	断电提醒	请等候 30 秒再重新打开电源开关
ARN UP	翻台开关报警	摆正机头, 确保翻台开关复原

3.4 故障代码表







若系统出现报错或报警, 请首先检查如下项:

- 1、先确认机器的连接线是否连接完好;
- 2、确认电控和机头是否匹配;
- 3、确认恢复出厂是否准确。

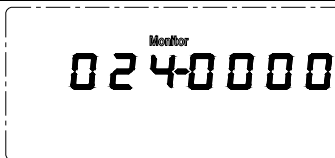

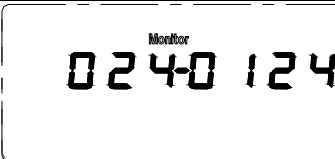
故障代码	代码含义	解决措施
Err-01	硬件过流	关闭系统电源，30 秒后重新接通电源，控制器若仍不能正常工作，请更换控制器并通知厂方。
Err-02	软件过流	
Err-03	系统欠压	断开控制器电源，检查输入电源电压是否偏低（低于 176V）。若电源电压偏低，请在电压恢复正常后重新启动控制器。若电压恢复正常后，启动控制器仍不能正常工作，请更换控制器并通知厂方。
Err-04	停机时过压	断开控制器电源，检查输入电源电压是否偏高（高于 264V）。若电源电压偏高，请在电压恢复正常后重新启动控制器。若电压恢复正常后，启动控制器仍不能正常工作，请更换控制器并通知厂方。
Err-05	运行时过压	
Err-06	电磁铁回路故障	关闭系统电源，检查电磁铁连线是否正确，是否有松动、破损等现象。若有则及时更换。确认无误后重启系统，若仍不能工作，请更换控制器并通知厂方。
Err-07	电流检测回路故障	关闭系统电源，30 秒后重新接通电源观察是否能正常工作。重试几次，若该故障频繁出现，请更换控制器并通知厂方。
Err-08	电机堵转	断开控制器电源，检查电机电源输入插头是否脱落、松动、破损，是否有异物缠绕在机头上。排除后重启系统仍不能正常工作，请更换控制器并通知厂方。
Err-09	制动回路故障	关闭系统电源，检查电源板上白色的制动电阻接头是否松动或脱落，将其插紧后重启系统。若仍不能正常工作，请更换控制器并通知厂方。
Err-10	HMI 通讯故障	检查控制面板与控制器的连线是否脱落、松动、断裂，将其恢复正常后重启系统。若仍不能正常工作，请更换控制器并通知厂方。
Err-11	机头停针信号故障	检查机头同步信号装置与控制器的连线是否松动，将其恢复正常后重启系统。若仍不能正常工作，请更换控制器并通知厂方。
Err-12	电机初始角度检测故障	请断电后再尝试 2-3 次，若仍报故障，请更换控制器并通知厂方。
Err-13	电机 HALL 故障	关闭系统电源，检查电机传感器接头是否松动或脱落，将其恢复正常后重启系统。若仍不能正常工作，请更换控制器并通知厂方。
Err-14	DSP 读写 EEPROM 故障	关闭系统电源，30 秒后重启系统，若仍不能正常工作，请更换控制器并通知厂方。
Err-15	电机超速保护	
Err-16	电机反转	
Err-17	HMI 读写 EEPROM 故障	
Err-18	电机过载	

4 特殊功能操作说明

4.1 上停针位调整

1		<p>控制系统在恢复出厂后，可根据需要重新设置上针位！ 第一步：先按住  键，显示 100-0000 参数，按  键，调整到 024 号监控参数，液晶屏显示当前角度，如为 0° 表明此位置为系统当前默认的上停针位置。</p>
2		<p>第二步：转动手轮，让挑线杆到上停针位置或希望调整到的合适位置，此时液晶屏显示调整后的上停针位，如 024-0124。</p>
3		<p>第三步：先按住  键，再按  键，使机械偏转角度归零，上停针位设置完成。最后按  键退出。</p>

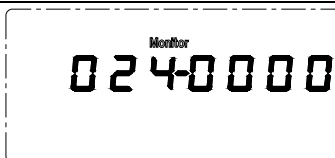
4.2 一键恢复机头厂家参数值

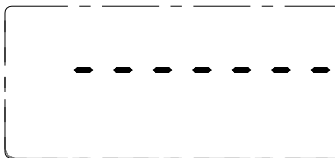
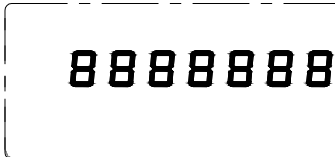
1		<p>如果希望恢复机头厂家的出厂参数，可按照如下步骤： 第一步：先按住  键，显示 100-0000 参数，按  键，调整到 024 号监控参数。</p>
2		<p>第二步：长按停针位键 3 秒钟以上，开始一键恢复机头厂家参数，液晶屏显示横杠，表明正在恢复参数，此时控制器切勿断电或拔出操作面板插头。</p>
3		<p>待数码管显示全 8，表明机头厂家参数恢复完成。</p>

4.3 脚踏板灵敏度调整

脚踏板动作由初始位置①（136 号参数）开始，缓慢向前踩至②（137 号参数）开始低速缝纫，继续前踩至③（138 号参数）开始加速，再深踩至④（139 号参数）达到最高速度。②③段之间维持起缝速度，③④段之间为无级调速过程；

1、当脚踏板由初始位置①（136 号参数）开始，缓慢后踩至⑤（135 号参数）时抬压脚自动抬起；

2、当脚踏板由初始位置①（136 号参数）开始，缓慢后踩至⑥（134 号参数）时自动完成剪线动作。

3、各参数数值设置需保证

(134 号参数) < (135 号参数) < (136 号参数) < (137 号参数) < (138 号参数) < (139 号参数)

4、可通过监控模式下 025 号参数实时监测不同位置下的踏板采样数值作为各参数的参考值。调整对应参数，抬压脚和前踩或后踩的动作位置也随之改变。如前踩很大距离机器还没有运转，可适当减小 137 参数（不能小于回中位置参数 136），即可提高前踩的灵敏度；若机器过于灵敏，轻触踏板机器就开始运行，可适当加大 137 参数；若不容易补针，稍微前踩，速度就迅速提高造成前冲多针，可适当增大 138 参数或减小 137 参数（即增大脚踏板低速范围），也可以适当降低初始起缝速度（100）。





图 4-1 踏板动作各位置参数示意图

386P0271B
2016-04-29

Contents

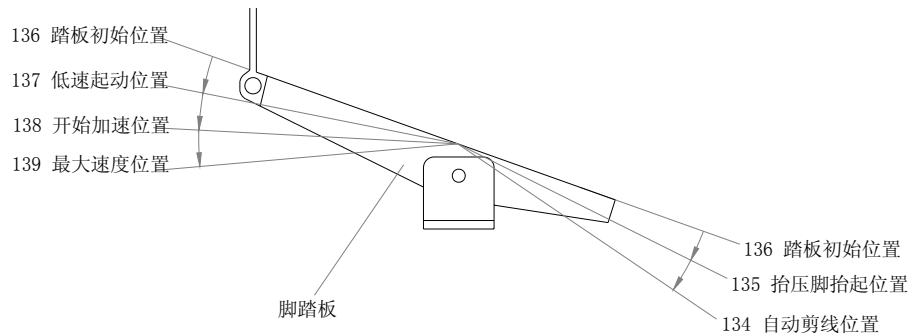
1. Installation Introduction	1
1.1 Product specifications	1
1.2 Interface connection	1
1.3 Wiring and Gounding	2
2 Operation Panel Instruction.....	3
2.1 Operation panel display instruction	3
2.2 The operation panel keys of description.....	4
3 System parameter setting	6
3.1 Technician mode.....	6
3.2 Monitoring Mode	10
3.3 Safety switch warning mode	10
3.4 False alarm mode	11
4 Special function operating instructions.....	12
4.1 Upper stop position adjust.....	12
4.2 A key recovery machine manufacturers parameter value.....	13
4.3 Pedal sensitivity adjustment.....	13

Safety Instruction

- Please read this manual carefully, also with related manual for the machinery before use the controller.
- For installing and operating the controller properly and safely, qualified engineers are required.
- Please stay away from arc welding equipment, in order to avoid electromagnetic interference and malfunction of the controller.
- Keep room temperature bellow 45°C and above 0°C
- Do not use in humidity below 30% or above 95% or dew and mist places.
- Please turn off the power and unplug the power cord, before install the control box and other components,
- To prevent interference or electric leakage accidents, please make the ground work; the power cord ground wire must be securely connected to earth by an effective way.
- All parts for the repair provided by the Company or approved before use.
- Please turn off the power and unplug the power cord before any maintenance action. There is dangerous high voltage control box, you must turn the power off after one minute before opening the control box.
- The symbol  in this manual means Safety Precautions, please pay attention to it and strictly follow it, to avoid any unnecessary damage.

1. Installation Introduction

1.1 Product specifications

Product Type	AHE5A	Supply Voltage	AC 220 ± 44 V
Power frequency	50Hz/60Hz	Maximum output power	550W

1.2 Interface connection

Connecting the plugs of pedaland machine head to the corresponding sockets at the back of controller, as Figure 1-2. Please check and confirm the plug is inserted firmly.

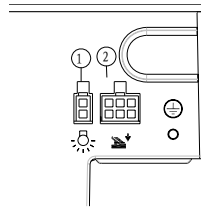
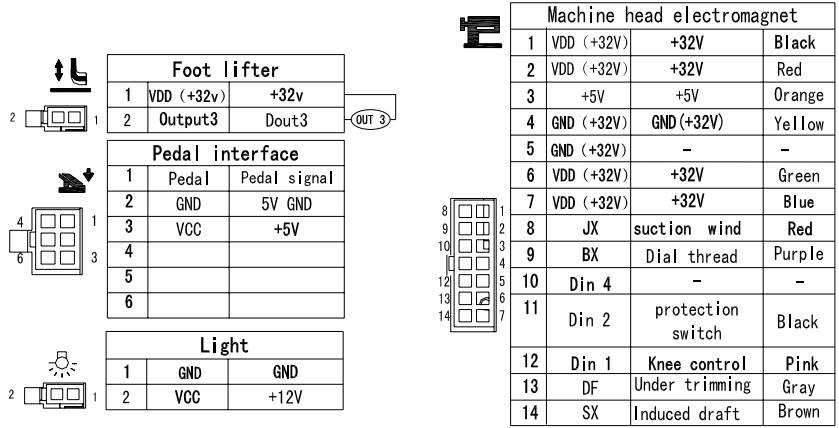



Fig.1-1 Controller Socket Diagram

① Light; ② Pedal socket .



1.3 Wiring and Grounding

We must prepare the system grounding project;a qualified electrical engineer is requested for the construction. Product is energized and ready for use; you must ensure that the power outlet the AC input is securely grounded. The grounding wire is yellow and green lines, it must be connected to the grid and reliable security protection on the ground to ensure safe use, and prevent abnormal situation.

: All the power line, signal line, ground wire connection not by other objects or excessive pressure to distort, in order to ensure the safe use!

2 Operation Panel Instruction

2.1 Operation panel display instruction

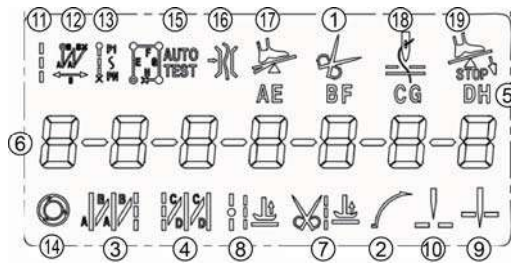
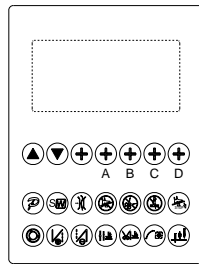

Fig.2-1 Operation Panel



















Fig.2-2 LCD Display













Table 2-1LCD Icon Display Description

Index	Icon	Description
①		Automatic Trimming
②		Soft start
③		Start back tacking
④		End back tacking
⑤		Sewing segments index
⑥		Number Display
⑦		Presser Foot Lifting after trimming
⑧		Presser Foot Lifting at Seam End
⑨		Position Down
⑩		Position up
⑪		Free Sewing
⑫		W Sewing
⑬		Multi-section Constant-Stitch Sewing
⑭		One-shot Sewing
⑮		Automatic Test
⑯		Thread clamp
⑰		Back half pedal function
⑱		Thread sweeping function
⑲		Start sewing

2.2 The operation panel keys of description

Table 2-2 Each key function introduction

Key	Name	Description
	Enter parameters and return key	Use the key to switch to the parameter mode. The key is parameters confirm key, and back to the previous menu until the operator sewing mode state. In addition, work with other key to achieve a combination of function.
	Mode SW. and save changes key	Under normal mode interface, press the key to SW. the cycle freely seam, W seam, multi-seam. Under the parameter mode, the modified parameters, press the key to save the parameters, and then a return to normal mode.
	Start back tacking setting key	Switch during all start tacking type when pressing. (No tacking, Once tacking  , double tacking  , 4 repeat tacking ). Tacking stitches A、B can be set using the  key and the  key. Interlock mode press this key can not set the start function. Parameters of interface, press once, the parameter NO. plus 1
	End back tacking setting key	Switch during all end tacking type when pressing. (No tacking, Once tacking  , double tacking  , 4 repeat tacking ). Tacking stitches C、D can be set using the  key and the  key. Interlock mode press this key can not set the start function. Parameters of interface, press once, the parameter NO. minus 1
	Clamp setting key	Clamp function is enabled (icon on) or disabled.
	One-Shot-Sewing Selection	In Constant-stitch sewing: a. One shot to the pedal, automatic performed number of stitches of every section. b. Toe down the pedal again and again to finish rest the sections until it finish pattern.
	Intermediate presser foot lifting mode	a. Press the key, indicating that the automatic presser foot valid parking during sewing. b. Click the icon off, show off sewing stop automatic presser foot lift function.
	Trimmer presser foot lifting mode	a. Press the key, indicating that automatic presser foot lift after thread trimming effectively. b. Click the icon off, show off thread trimming stop automatic presser foot lift function.

Key	Name	Description
	Soft start setting key/ LED lamp	Soft start at the first seam is enabled (icon on) or disabled. Long press  key, adjustable LED lamp the third gear of brightness
	Needle position key	The sewing halfway function is stop that the system of up/down needle stop position selection
 	Increasing and decreasing motor speed	Under the multi-slit mode, It can be quickly set up temporary speed governor. Furthermore, when the parameter settings, a single press the key, the corresponding parameter number increases.  key+ the key, the corresponding parameters number decreasing.
	parameters Increase key	Adjust the corresponding increase in the value of the key.  key+ the  key, the corresponding value decreases
	Automatic trimming	Automatic trimming mode is enabled (icon on) or disabled.
	After a half step key	After a half step function is enabled (icon on) or disabled.
	Thread sweeping key	Thread sweeping function is enabled (icon on) or disabled.
	Start sewing	Start sewing function is enabled (icon on) or disabled.

3 System parameter setting

3.1 Parameter mode

- 1, In the normal mode, press P key to enter parameter mode A;
- 2, press the corresponding \uparrow/\downarrow key and $\text{+}/\text{-}$ key can be increased to the parameter number and the parameter value. Press the $\text{P} + \uparrow/\downarrow$ and $\text{P} + \text{+}/\text{-}$ keys can be reduced to the parameter number and parameter values;
- 3, press + and - keys can add and subtract this paragraph parameter index number
- 4, when the parameter values are addition and subtraction, the parameter interface flashes. In this case, press S to save the changes, the interface is no longer flashing. Press the S key to exit the parameter interface, return to normal mode;
- 5, In parameter mode, press the P key, change the value is not saved, return to the normal mode.

NO.	Range	Default	Description
100	100-800	200	Minimum speed
101	200-5000	3500	Maximum speed
102	200-5000	3000	Constant-stitch sewing speed
103	200-5000	3000	Manually backstitch maximum speed limit
104	100-800	200	Complement Needle speed
105	100-500	250	Trimming speed
106	0 / 1	0	Soft start mode: 0: Soft start only after trimming 1: Soft start after both trimming and stop
107	1-9	2	Stitch numbers for soft start
108	100-800	200	Soft start speed
130	0 / 1 / 2 / 3	2	Speed curve adjustments: 0: ramp curve 1: polygonal curve 2: quadric curve 3: S-type curve
131	200-4000	3000	The turning point speed of two segment curve.
132	0-1024	800	The turning point sampling voltage of the pedal when two segment curve (Between parameter 138 and 139)
133	1 / 2	1	The type of polygonal curve: 1: square 2: rooting

134	0~1024	90	Trimming point of pedal	Figure 4-1 shows the specific setting method
135	0~1024	300	Footer lifting point of pedal	
136	0~1024	460	Neutral point of pedal	
137	0~1024	480	Motor running point of pedal in low speed.	
138	0~1024	580	Accelerated point of pedal	
139	0~1024	962	Max speed point of pedal	
13E	1~800	100	After trimmer the press lifter delay time (dial line)	
140	0 / 1	1	Soft start at the first cycle of power ON. 0: Disable 1: Enable	
143	0 / 1 / 2 / 3	0	Special mode: 0: Normal Mode 1: Simply sewing mode 2: Motor initial angle measurement (Do not remove the belt) 3: Automatically setting the pulley ratio by the CPU. (synchronizer is necessary and the belt not removed)	
144	0~31	0	Feedforward torque of motor: 0: Normal functions 1-31: Feedforward torque level	
149	0~10	0	The time of chopping on for the presser foot slow down (uint is 100us)	
150	1~100	1	The proportion coefficient of the stitches counter	
151	1~9999	1	Maximum stitches of the counter	
152	0~6	0	Count mode selection (For Bobbin Thread) 0: The counter is invalid 1: Count up by stitches. When count over, counter will be auto-reset. 2: Count down by stitches. When count over, counter will be auto-reset. 3: Count up by stitches. When count over, motor stops and the counter must be reset by the external switch or the P key on the panel. 4: Count down by stitches. When count over, motor stops and the counter must be reset by the external switch or the P key on the panel. 5: Count up by trimming. When count over, panel alarms and motor stops after trimming. 6: Count down by trimming. When count over, panel alarms and motor stops after trimming.	

153	1~100	1	The proportion coefficient of the pieces counter
154	1~9999	1	Maximum pieces of the counter
155	0~4	0	Count mode selection (For Sewing Piece) 0: The counter is invalid 1: Count up by pieces. When count over, counter will be auto- reset. 2: Count down by pieces. When count over, counter will be auto- reset. 3: Count up by pieces. When count over, motor stops and the counter must be reset by the external switch or the P key on the panel. 4: Count down by pieces. When count over, motor stops and the counter must be reset by the external switch or the P key on the panel.
156	0~9999	0	The output chopping duty cycle of No. 1/2/3/4 solenoid in each bit.
157	0~9999	0	The output chopping duty cycle of No. 5/6/7/8 solenoid in each bit.
158	0~1	0	Counter adjustable: 0:adjustable, 1:not adjustabled
160		0	Running time reset
161	0/1/2		Direction of parameter transfer: 0: no action 1: from operation panel to controller 2: from controller to operation panel.
165	-		Restore the default factory setting, and cover the user defined para setting,.
200	0/1/2	0	Trimming mode selection: 0: lockstitch machine 1: interlock machine: Needle stops at the up position and trim. 2: overlock machine: manual trimming
202	0/1/2/ 3/4/5/6	1	trimming timing options: 0: 203 parameter setting angle [TS] Department to conduct a tangent, until up needle stop after the delay time set by 206 parameter [T2] so far. 1: 203 parameter setting angle [TS] Department to conduct a tangent, until No. 204 parameter setting angle [TE] so far. 2: 203 Number parameter setting angle [TS] Department to conduct a tangent, set the delay time parameter 206 [T2] so far. 3: After the needle position signal delay time set by parameter No. 205 [T1] be the tangent, the delay time set by parameter 206 [T2] to set the time so far.

			<p>4: find the needle position signal delay time set by parameter No. 205 [T1] be the tangent, the delay time set by parameter 206 [T2] to set the time until the majority applied stretch sewing machine.</p> <p>5: find the next needle position signal after start tangent action-oriented stop needle stop. Then set the delay time parameter No. 205 [T1] and then set the parameters for the 206 tangent time [T2]. (Mostly used for general flat car models, and most of the T1 and T2 set values are set to 0)</p> <p>Toshiba tangentially oriented needle stop only 203 parameters set by the angle [TS] Office:</p> <p>6. Then set the delay time parameter No. 205 [T1] and then set the parameters for the 206 tangent time [T2].</p>
203	5-359	10	Trimming output start angle TS (down needle position angle as the reference point) (flat sewing)
204	10-359	120	Trimming output end angle TE (Down needle position angle is the reference and this value should be bigger than TS) (flat sewing)
205	1-999	10	Trimmer start delay T1 (ms) (interlock)
206	1-999	120	Trimmer end delay T2 (ms) (interlock)
211	5-359	25	Thread release output start angle LS (down needle position angle as the reference point)
212	10-359	350	Thread release output end angle LE (Down needle position angle is the reference and this value should be bigger than LS)
213	1-999	1	Thread release output start delay time T1 (ms)
214	1~999	10	Thread release output end delay time T2 (ms) after up needle position
216	1~999	10	Wiper output delay time (ms)
217	1~9999	70	Wiper duration time (ms)
218	1~999	50	Wiper recovery time (ms)
219	0 / 1	0	Thread clamp function 0: disable 1: enable
21E	11-359	160	The angle of presser foot solenoid off during thread clamping
220	200~360	360	Stop position after trimming (motor can stop with a reverse angle)
231	0 / 1	0	Auto test mode: 0: stitches mode 1: time mode
232	0~1000	300	Safe switch filtering time (ms)

234	0 / 1	0	Motor direction: 0: CW 1: CCW
240	0~9999	1000	The ratio between motor and machine (1000 stands for 1:1)
242	0~359	0	Up needle stop angle (After detecting the synchronizer signal)
243	0~359	175	Down needle stop angle
244	0~800	200	Running delay time when presser footer comes down (ms)
247	0~2000	0	The alarm time for adding oil (hours), disabled when setting 0
248	0~4000	0	Gas alarm, prohibit running time (hour) 0: close this feature

3.2 Monitoring Mode

No.	Description	No.	Description
010	Counter for stitches	026	The ratio between motor and machine
011	Counter for sewing pieces	027	The total used time(hours) of motor
013	State of encoder	028	The sampling voltage of interaction
020	DC voltage	029	Software version
021	Machine speed	02A	analog input 1 sample value
022	The phase current	02b	analog input 2 sample value
023	Initial electrical angle	02C	Error Counter
024	Machine angle	02d	QP Ultra-state
025	The sampling voltage of pedal	030-037	The history record of error codes

3.3 Safety switch warning mode

Alarm code	Description	Corrective
ALA-1	Fuel filling warning	Fuel filling. Press P key to clear.
ALA-2	Count over for stitches	The counter reaches the limit. Press P key to reset the counter.
ALA-3	Count over for sewing pieces	The counter reaches the limit. Press P key to reset the counter.
ALA-4	Emergency stop	Press the key of emergency stop to clear.
ALA-5	Lift needle locking	Then press the needle lifting locking button, can eliminate the needle lifting locking state
POH OFF	Power is off	Please wait for 30 seconds, then turn on the power switch
RPN UP	Safety switch alarm	Adjust the machine to the correct position.

3.4 False alarm mode

If the system error or warning, please first check the following items:

- 1, to confirm the connection machine is connected properly;
- 2, confirm the control and head matches;
- 3, confirm restore factory is accurate.

error code	meaning	solution
Err-01	hardware overflow	Turn off the system power, restart after 30 seconds, if the controller still does not work, please replace it and inform the manufacturer.
Err-02	software overflow	
Err-03	system under-voltage	Disconnect the controller power and check if the input voltage is too low (lower than 176V). If yes, please restart the controller when the normal voltage is resumed. If the controller still does not work when the voltage is at normal level, please replace the controller and inform the manufacturer.
Err-04	over-voltage when the machine is off	Disconnect the controller power and check if the input voltage is too high (higher than 264V). If yes, please restart the controller when the normal voltage is resumed. If the controller still does not work when the voltage is at normal level, please replace the controller and inform the manufacturer.
Err-05	over-voltage in operation	
Err-06	solenoid circuit failure	Turn off the system power, check if the solenoid is connected correctly and if it is loose or damaged. If yes, replace it in time. Restart the system upon making sure everything is in good order. If it still does not work, seek technical support.
Err-07	electrical current checking circuit failure	Turn off the system power, restart after 30 seconds to see if it works well. If not, try several more times. If such failure happens frequently, seek technical support.
Err-08	locked motor roller	Disconnect the controller power, check if the motor input plug is off, loose or damaged, or if there is something twined on the machine head. After checking and correction, if the system still does not work, please replace the controller and inform the manufacturer.
Err-09	brake circuit failure	Turn off the system power, check if the white brake resistance plug on the power board is loose or dropped off, fasten it and restart the system. If it still does not work, please replace the controller and inform the manufacturer.
Err-10	HMI communication failure	Check if the connecting line between control panel and controller is off, loose or broken, restore it and restart the system. If it still does not work, please replace the controller and inform the manufacturer.
Err-11	machine head needle positioning failure	Check if the connection line between machine head synchronizer and controller is loose or not, restore it and restart the system. If it still does not work, please replace the controller and inform the manufacturer.
Err-12	motor original angle checking failure	Please try 2 to 3 more times after power down, if it still does not work, please replace the controller and inform the manufacturer.



Err- 13	Motor HALL failure	Turn off the system power, check if the motor sensor plug is loose or dropped off, restore it and restart the system. If it still does not work, please replace the controller and inform the manufacturer.
Err- 14	DSP Read/Write EEPROM failure	Turn off the system power, restart the system after 30 seconds, if it still does not work, please replace the controller and inform the manufacturer.
Err- 15	Motor over-speed protection	
Err- 16	Motor reversion	
Err- 17	HMI Read/Write EEPROM failure	
Err- 18	Motor overload	
Err- 19	Lack of oil alarm	Add oil to the needle rod, and set the P22 parameter at 4000, resume the working time after the last oil adding; or you can press button P to close the alarm and continue to use.

4 Special function operating instructions

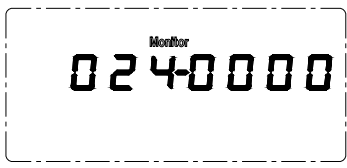
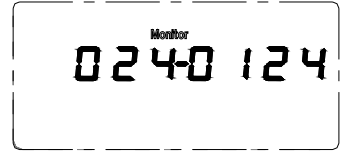
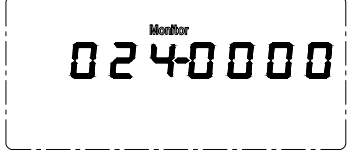
4.1 Upper stop position adjust

1		Step 1: Press P key,.Parameter 100 is shown,press Δ key, Adjust to 024 monitoring parameters,as for 0°,which means the default up needle stop position in angle.
2		Step 2: Turn the hand wheel and adjust to the right position as up needle stop, and the needle position angle is shown simultaneously.
3		Step 3: Press $\text{P}+$ P key, the new up needle position is preserved and the parameter is set to zero.

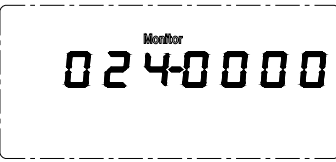
4.2 A key recovery machine manufacturers parameter value

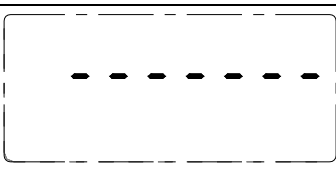
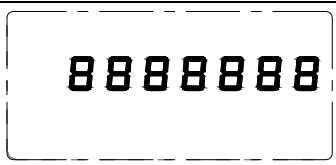
1		<p>Step 1: Press  key,.Parameter 100 is shown,press  key, Adjust to 024 monitoring parameters.</p>
2		<p>Step 2: Press stop needle key for about 3seconds, then Default Factory Setting is recovered displaying as left LCD.</p>
3		<p>When the LCD is displayed as 8888888, the recovery is accomplished. The machine is recovered back to the initial state in delivery.</p>

4.3 Pedal sensitivity adjustment

Pedal movement by the initial position of the (parameter 136) began, slowly forward step to the (parameter 137) began to low-speed sewing, before continuing on to the (parameter 138) began to accelerate, and then on to the deep (parameter 139) reach maximum speed. In the period of maintenance of sewing speed, stepless speed regulation process between the segment;

- 1、 n the pedal from the initial position to the (parameter 136) began to slow, after stepping on to the (parameter 135) when the presser foot lift automatically;
- 2、 hen the pedal from the initial position to the (parameter 136) began to slow, after stepping on to  (parameter 134) automatically complete shear line.

A value of

- 3、 the parameter settings are required to ensure that
 (parameter 134) < (parameter 135) < (parameter 136) < (parameter 137) < (parameter 138) < (parameter 139)

4、an be used as the parameter's value through the pedal real-time monitoring of 025 parameters at different positions of the monitoring mode sampling numerical. Adjusting the corresponding parameters, presser foot and step on or after step action position change. As on the great distance machine is not running, may be appropriate to reduce the 137 parameters (not less than to the location parameters in 136), can improve the sensitivity of feet; if the machine is too sensitive, touch the pedal machines began to work, it may be appropriate to increase the 137 parameters; if it is not easy to fill needle, a little feet, speed quickly improve the cause forward multi needle, may be appropriate to increase or decrease the 138 parameters of 137 parameters (i.e. adding feet pedal speed range), can also be appropriate to reduce the initial seam speed (100).

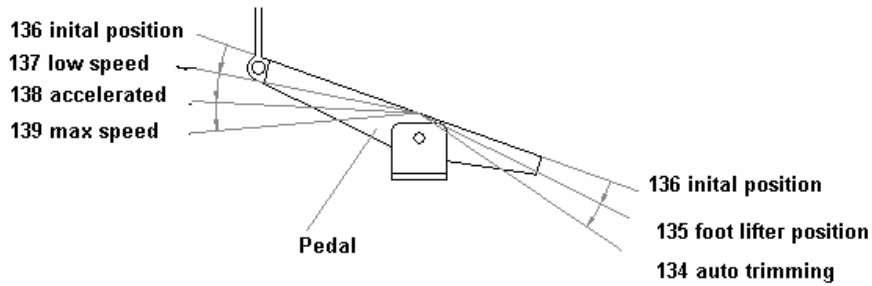

Fig. 4-1 pedal movement of each position parameter

386P0271B

2016-04-29

SPIS TREŚCI

1. Smarowanie	1
2. Smarowanie ręczne	1
3. Napełnianie urządzenia HR olejem silikonowym	2
4. Schemat nawlekania	3
5-1. Schemat nawlekania	3
5-2. Schemat nawlekania	3
6. Regulacja ciśnienia stopki dociskowej	3
7. Regulacja podawania różnicowego	4
8. Regulacja długości ściegu	4
9. Regulacja naciągu nici	5
10. Czyszczenie maszyny	5
11. Wymiana igły	5
12. Sprawdzanie obiegu oleju	6
13. Sprawdzanie i wymiana filtra olejowego	6
14. Wymiana oleju	6
15. Regulacja wymiarów	7

Instrukcja obsługi

1. Smarowanie

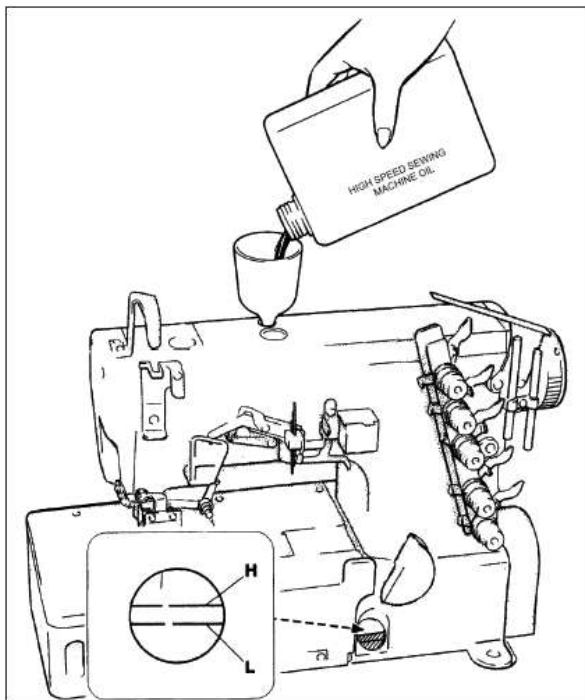

1. Po napełnieniu miski olejowej powierzchnia oleju powinna znajdować się pomiędzy liniami (H) a (L). Dolać oleju, gdy powierzchnia oleju osiągnie poziom lub spadnie poniżej (L).

2. Smarowanie ręczne

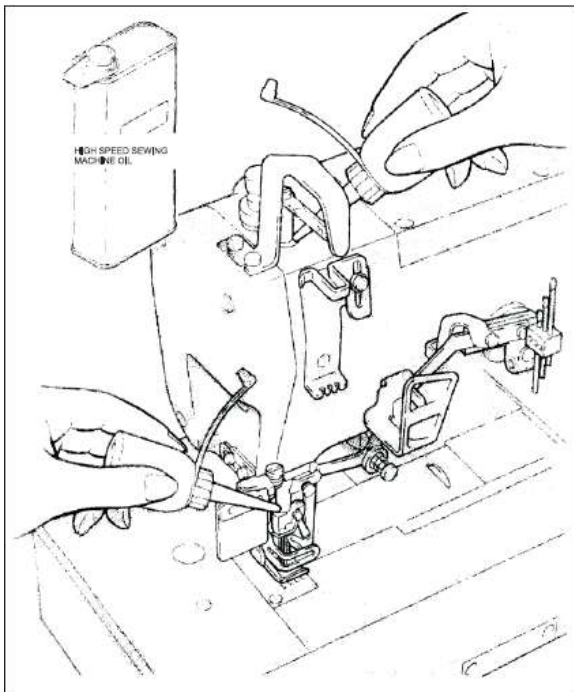

1. Nałożyć 2 lub 3 krople oleju ręcznie, gdy maszyna jest używana po raz pierwszy lub stała nieużywana przez jakiś czas.

3. Napełnianie urządzenia HR olejem silikonowym

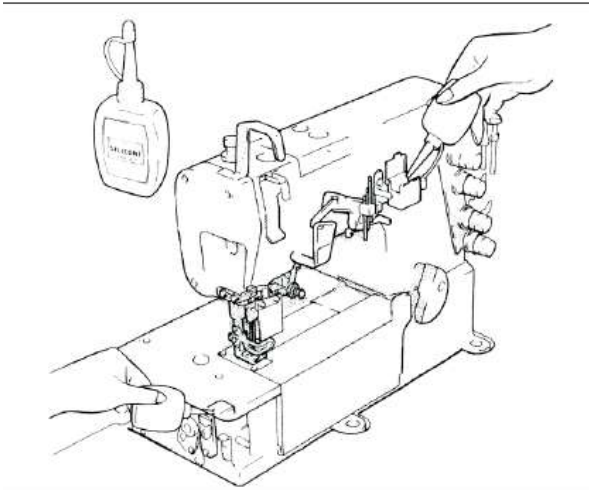

1) Napełnić urządzenie HR olejem, zanim jego poziom będzie zbyt niski, aby zapobiec zerwaniu nici i uszkodzeniu tkaniny.

Uwaga: Używać zalecanego oleju Pegasus [UNION CARRBIDE CORPORATION] UCC L-45(350)

4. Nawlekanie

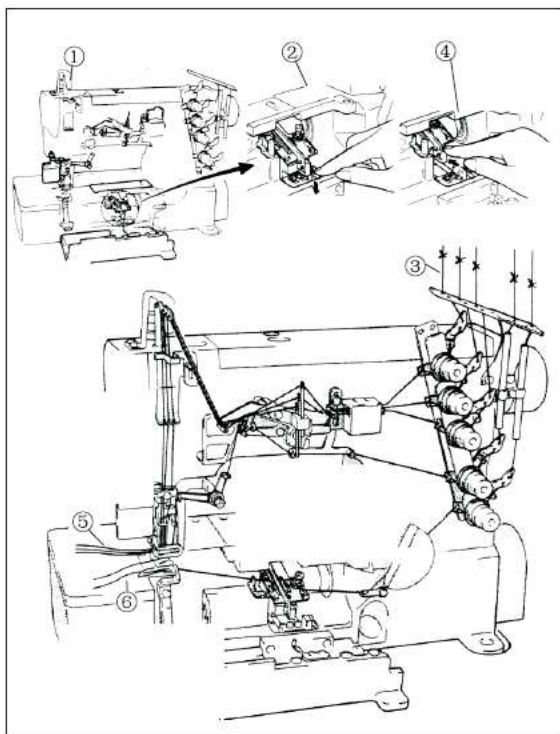

- 1) Otworzyć osłonę i trzy pokrywy.
- 2) Wcisnąć w dół. (Pobranie nici przez pętłownicę po nawleczeniu).
- 3) Związać wstępnie ustawioną nić i używaną nić razem, aby nawlec maszynę.
- 4) Wymienić pobraną nić przez pętłownicę po nawleczeniu.
- 5) Nawlec nić. Ostrożnie przyciąć węzły przed przejściem przez oko igły w celu ponownego nawleczenia.
- 6) Nić w pętłownicy, nić pokrywy górnej. Ostrożnie przyciąć węzły po przejściu przez oko pętłownicy.
- 7) Pamiętaj o prawidłowym nawleczeniu maszyny - patrz schemat nawlekania.

5-1. Schemat nawlekania

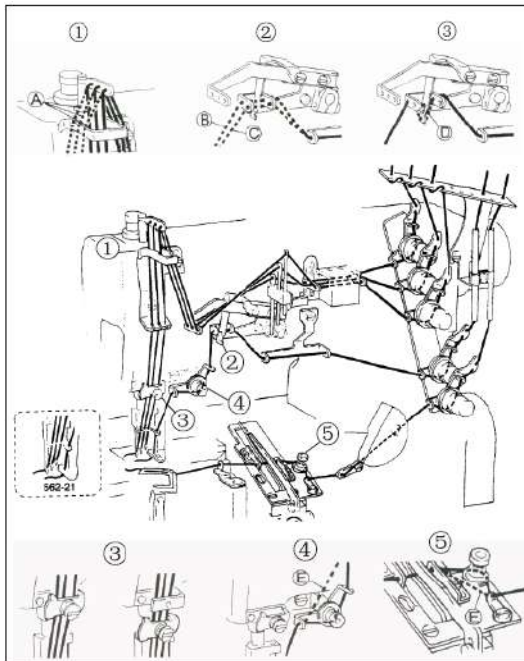

- (1) Złamane linie A do bardziej rozciągliwych nici.
- (2) W górnej pokrywie nić jest zbyt luźna, użyć złamanej linii B. Jeśli w górnej pokrywie nić jest nadal zbyt luźna po nawleczeniu za pomocą złamanej linii B, użyć złamanej linii C.
- (3)-1 Do bardziej rozciągliwych nici.
- (3)-2 Do bardziej rozciągliwych nici.
- (4) Złamane linie E do bardziej rozciągliwej nici (Linie ciągłe do zwykłych nici).

5-2. Schemat nawlekania

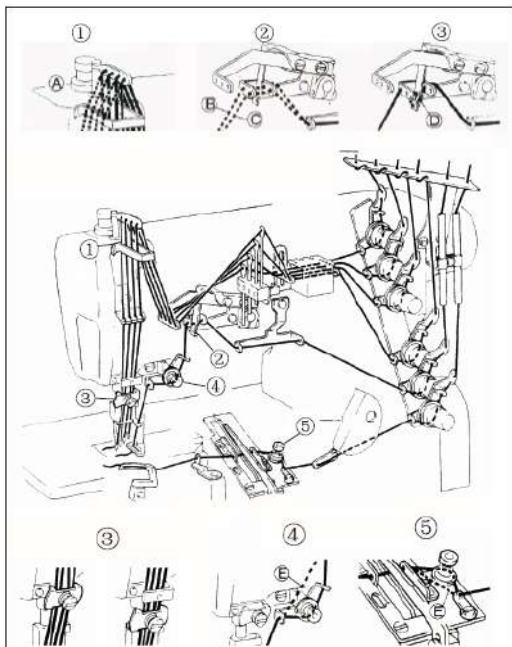

- (1) Złamane linie A do bardziej rozciągliwych nici.
- (2) W górnej pokrywie nić jest zbyt luźna, użyć złamanej linii B. Jeśli w górnej pokrywie nić jest nadal zbyt luźna po nawleczeniu za pomocą złamanej linii B, użyć złamanej linii C.
- (3)-1 Do bardziej rozciągliwych nici.
- (3)-2 Do bardziej rozciągliwych nici.
- (4) Złamane linie E do bardziej rozciągliwej nici (Linie ciągłe do zwykłych nici).

6. Regulacja ciśnienia stopki dociskowej

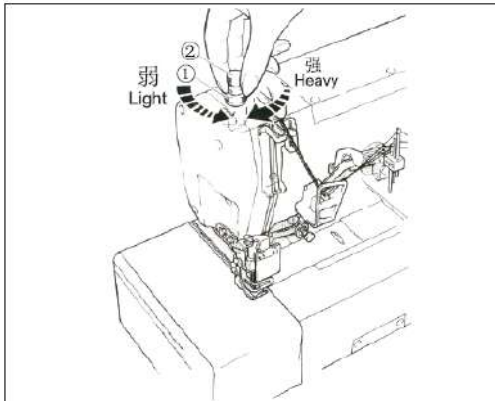

1) Okręcić nakrętkę regulacyjną (1) i przekręcić śrubę regulacyjną ②, aby wyregulować ciśnienie stopki dociskowej.

Powinno być możliwe jak najłżejsze, ale wystarczające do uzyskania właściwego formowania ściegów.

7. Regulacja podawania różnicowego

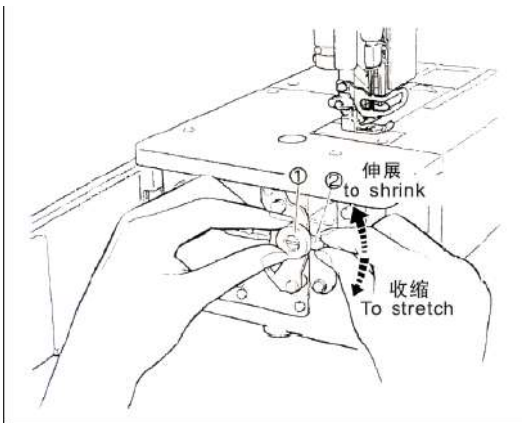

1) Odkręcić nakrętkę (1) i przesunąć dźwignię do góry (2) i w dół, aby uzyskać prawidłowe podawanie różnicowe, następnie dokręcić nakrętkę (1).

8. Regulacja długości ściegu

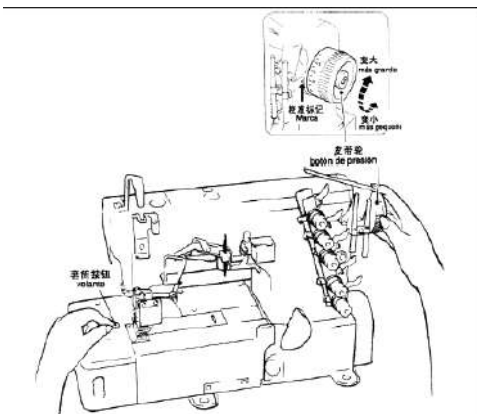

- 1) Naciskając przycisk, obracać pokrętkę, aby wyszukać pozycję, w której przycisk wchodzi dalej w głąb.
 - 2) Następnie, trzymając wciśnięty przycisk, obracać pokrętkę i ustawić żadaną skalę do znaku wyrównania.
- Uwaga: Regulację długości ściegu można przeprowadzić dopiero po zmianie prędkości podawania różnicowego.

9. Regulacja naciągu nici

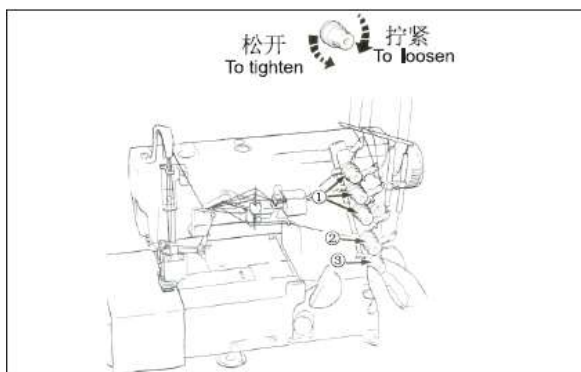

1) Wyregulować naciąg pokrętkiem gwintu igły (1), pokrętkiem górnym pokrywy nici (2) i pokrętkiem dolnym pętlownicy (3). [tighten – ściślej; loosen – luźniej]

10. Czyszczenie maszyny

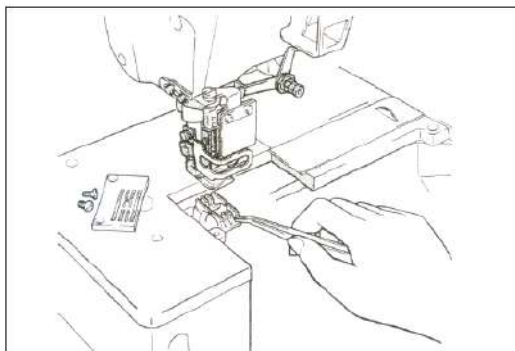

1) Czyścić należy głównie rowki płytki ściegowej i rowki mechanizmu posuwu.

11. Wymiana igły

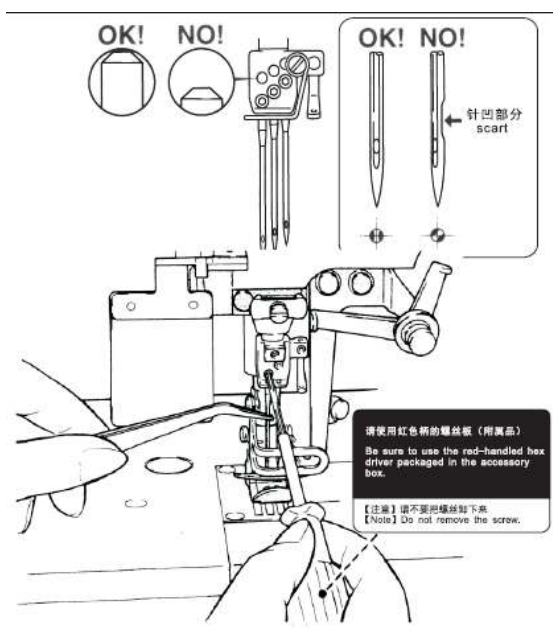

- 1) Sprawdzić dokładnie igłę, aby zobaczyć, czy zagłębienie jest zwrócone w tył maszyny.
 - 2) Włożyć igłę na właściwą głębokość i bezpiecznie ją zamocować.
 - 3) Koniecznie użyć standardowej igły.
- Zob. WYMIARY REGULACJI na końcu instrukcji.

12. Sprawdzanie obiegu oleju



- 1) Sprawdzić stan obiegu oleju, po dodaniu oleju, proszę sprawdzić stan przetworzenia oleju przez wziernik olejowy.

13. Sprawdzanie i wymiana filtra oleju

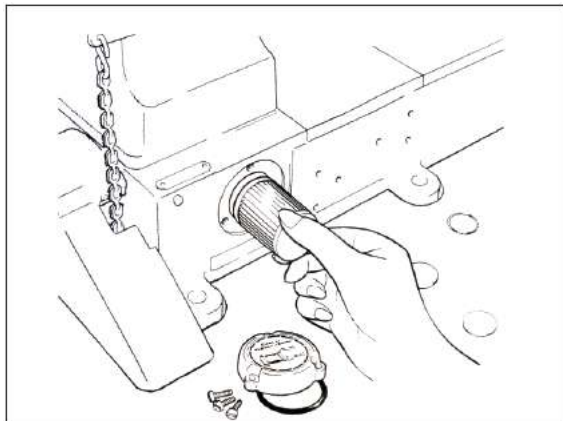

- 1) Sprawdzać i wymieniać filtr oleju co sześć miesięcy. UWAGA: W maszynach z urządzeniem UT zdemontować uchwyt elektromagnesu.

14. Wymiana oleju

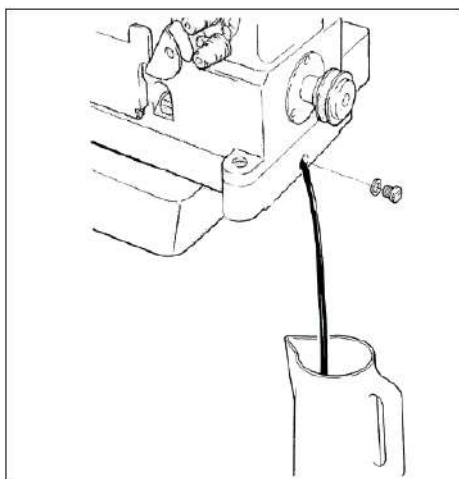











1) Po używaniu maszyny przez miesiąc należy wymienić olej, a następnie wymieniać olej co 6 miesięcy. Jeśli nadal będzie używać się starego oleju, maszyna do szycia może źle działać.

15. Wymiary regulacji (mm)

562-01C 542							
02R 02S	224	10.2	4.8-5.1	8.3-8.7	4.5-5.0	17.0	0.8-1.2
03D 03E	232	9.8	4.4-4.7	8.3-8.7	4.5-5.0	17.0	0.8-1.2
05R 05C	240	9.3	4.0-4.3	8.3-8.7	4.5-5.0	17.0	0.8-1.2
05S 06R	248	8.9	3.6-3.9	8.3-8.7	4.5-5.0	17.0	0.8-1.2
07R 08A	256	8.5	3.2-3.5	8.3-8.7	4.5-5.0	17.0	0.8-1.2
-01G 02 D	264	8.1	2.8-3.1	8.3-8.7	4.5-5.0	17.0	0.8-1.2
82A	348	9.4	3.6-3.9	8.8-9.2	4.5-5.0	17.0	0.8-1.2
	356	8.5	3.2-3.5	8.3-8.7	4.5-5.0	17.0	0.8-1.2
	364	8.1	2.8-3.1	8.3-8.7	4.5-5.0	17.0	0.8-1.2
562-01D	460	9.3-9.8	2.8-3.1	8.7-9.2	4.8-5.2	17.2	0.8-1.2
562-01C	232	9.3	4.4-4.7	7.8-8.2	4.5-5.0	17.0	0.8-1.2
	240	8.8	4.0-4.3	7.8-8.2	4.5-5.0	17.0	0.8-1.2
562-01B 542	356	9.3	3.7-4.0	9.7-10.2	4.5-5.0	17.0	1.2-1.5
	364	8.8	3.3-3.6	9.7-10.2	4.5-5.0	17.0	1.2-1.5

(mm)

	X□□□			
542-84A	232	9.8	4.4-4.7	0.8-1.2
522-04A -04 B	264	11.5	4.5-4.7	0.8-1.2
	295	11.5	4.5-4.7	0.8-1.2

	X□□□								
522 - 01F	264	11.0	4.0-4.5	9.4	5.0-5.5	20.5- 21.0	0.8- 1.2	0.5	0.5-1.0

Panel operacyjny AS58 (HMI) - Instrukcja

1 Obsługa panelu operatora

Panel operatora (zob. rys. 1-1) dzieli się na dwie części: wyświetlacz LCD i przyciski funkcyjne.

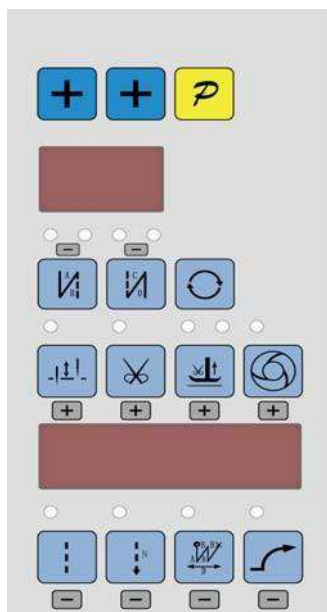









Rys. 1-1

Wyświetlacz cyfrowy składa się z 6 sekcji cyfrowych używanych do ustawiania wszystkich parametrów. Panel ma 14 przycisków używanych do wyświetlania kluczowych funkcji (otwartych lub nie).

Cześć przycisków ma podświetlenie LED. Tabela 1 pokazuje funkcje każdego przycisku.

Tabela 1: Poniżej znajdują się instrukcje dotyczące każdego przycisku:

Nr	Wygląd	Opis
1		Przycisk funkcji: Potwierdź działanie lub użyj innego przycisku.
2		Przycisk cyklu: Zmień pozycję parametru przy zmianie parametru.
3		Przycisk plus: Zwiększa wartość parametru o 1
4		Przycisk startu fastrygowania wstecznego: Runda pojedynczego startu fastrygowania wstecznego; podwójny start fastrygowania wstecznego; kwadratowy start wstecz i zamknięcie startu fastrygowania wstecznego. LED 2 na górze przycisku pokazuje bieżący status.
5		przycisk końca fastrygowania wstecznego: Runda pojedynczego końca fastrygowania wstecznego; podwójny koniec fastrygowania wstecznego; kwadratu końca fastrygowania w tył i zamknięcie końca fastrygowania w tył. LED 2 na górze przycisku pokazuje bieżący status.

6		Przycisk pozycji stop: Wybrać pozycję zatrzymania góra/dół/Zwiększyć bit tysięczny. Dioda LED w lewym górnym rogu przycisku jest podświetlona, gdy wybrana jest pozycja zatrzymania u góry.
7		Przycisk lamówkowania: Wybierz/odznacz automatyczne lamówkowanie/Zwiększ bit setny. Dioda LED w lewym górnym rogu przycisku jest podświetlona, gdy wybrane jest automatyczne lamówkowanie.
8		Nacisnąć przycisk podnoszenia stopki : Ustaw automatyczne podnoszenie stopki dociskowej/Zwiększ bit dziesiąty. Wybierz podnoszenie stopki dociskowej i podnoszenie stopki środkowej. LED 2 na górze przycisku pokazuje bieżący status.:
9		Przycisk szycia One-Shot: Wybierz/odznacz szycie One-Shot/ Zwiększ bit wejścia. Dioda LED świeci się w górnym lewym rogu przycisku, gdy wybrane jest szycie One-Shot.
10		Przycisk trybu szycia swobodnego: Wybierz tryb szycia swobodnego/ Zmniejsz bit tysięczny. Dioda LED świeci się w górnym lewym rogu przycisku podczas pracy.
11		Przycisk trybu szycia wielosegmentowego: Wybierz tryb szycia wielosegmentowego/Zmniejsz bit setny. Dioda LED świeci się w górnym lewym rogu przycisku podczas pracy.
12		Przycisk trybu szycia W: Wybrać tryb szycia W/Zmniejszyć bit dziesiąty. Dioda LED świeci się w górnym lewym rogu przycisku.
13		Przycisk łagodnego startu: Wybierz funkcję łagodnego startu/Zmniejsz bit wejść. Dioda LED świeci się w górnym lewym rogu przycisku.

2 Opcjonalny tryb użytkownika

2.1 Tryb operatora

Jest to tryb domyślny panelu operatora, panel operatora wchodzi w ten tryb po uruchomieniu. W trybie tym dwa punkty dziesiętne połączenia będą świecić od lewej do prawej strony w uporządkowany sposób podczas biegu, (LED pokazane jako ), co oznacza, że HMI jest w stanie czuwania.

Przed wykonaniem dowolnego działania, jeśli przyciski nie są długo wciskane, HMI automatycznie przełączy się stan czuwania; poprzednie działania nie zostaną wykonane.

2.1.1 Konfiguracja trybu szycia:

Tryb szycia dowolnego: Nacisnąć przycisk 10, dioda LED pokazuje się jako









, jeśli wciśniesz przycisk, potwierdź działanie, lampa wyświetlacza

cyfrowego wraca do stanu czuwania, a dioda LED z lewej strony u góry przycisku  jest podświetlona.





Tryb szycia wielosegmentowego: Naciśnij przycisk 11 , znak wyświetlacza cyfrowego



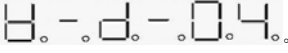

status szycia wielosegmentowego. Za pomocą  czterech przycisków (9, 13, 8, 12) ustawić tryb szycia wielosegmentowego (segment 24 najwyższy), potem wcisnąć 2 , aby wprowadzić numer szwu szycia wielosegmentowego każdego statusu konfiguracji segmentu i lampki wyświetlacza cyfrowego .



Za pomocą czterech przycisków (3, 4, 6, 10) modyfikować indeks segmentu, za pomocą  czterech przycisków (9, 13, 8, 12), aby zmienić numer ściegu szycia wielosegmentowego każdego segmentu. Po naciśnięciu przycisku , aby potwierdzić pracę, znak cyfrowy podświetli się i wyświetli stan czuwania. Dioda LED w lewym górnym rogu przycisku  świeci się, jeśli tryb szycia wielosegmentowego jest otwarty.

Tryb szycia W: Nacisnąć przycisk 12 , 8-segmentowa dioda LED wyświetli status szycia W,

. Naciśnięcie przycisku  (6, 10) pozwala wybrać segment A B D i użyć  (9, 13, 8, 12), aby zmodyfikować ściegi każdego segmentu. Po potwierdzeniu, wcisnąć przycisk , 8-segmentowy wyświetlacz LED wróci do stanu czuwania, a dioda LED u góry po lewej przycisku  będzie się świecić.

2.1.2 Konfiguracja startu/końca fastrygowania w tył:

Po naciśnięciu przycisku 4  lub 5  8-segmentowa dioda LED wyświetli status startu fastrygowania w tył lub status końca fastrygowania w tył.



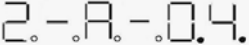
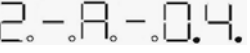
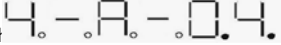

Wcisnięcie przycisku 4  aktywuje pojedynczy start fastrygowania wstecznego , podwójny start wstecznego

fastrygowania , start kwadratu w tył , zamknięcie startu w tył .



Naciśnięcie przycisku 5  aktywuje pojedynczy koniec fastrygowania wstecznego; podwójny koniec fastrygowania wstecznego; koniec wstecznego kwadratu, zamknięcie

koniec fastrygowania w tył (Rys. poniżej). Wcisnąć przycisk (6、10), aby wybrać segment A、B lub C、D, i użyć przycisków (9、13、8、12), aby wybrać ściegi dla każdego segmentu. Po potwierdzeniu, wcisnąć przycisk ,







wyświetlacz LCD wróci do stanu czuwania, a dwie diody LED na przycisku startu fastrygowania w tył i przycisku końca fastrygowania w tył zaświecą się, aby odpowiednio wskazać status.

- ◆ Gdy dwie diody LED na przycisku  wyłączą się, oznacza to brak fastrygowania w tył;
- ◆ Gdy dioda LED po lewej u góry przycisku  jest włączona, a po prawej u góry wyłączona, oznacza to pojedyncze fastrygowanie w tył;
- ◆ Gdy dioda LED po lewej u góry przycisku  jest włączona, a po prawej u góry wyłączona, oznacza to pojedyncze fastrygowanie w tył;
- ◆ Gdy obie diody LED na przycisku  świecą się, oznacza to kwadratowe fastrygowanie w tył;
Uwaga: Zapewniamy tylko start fastrygowania w tył, to samo z przyciskiem końca fastrygowania w tył



2.1.3 Konfiguracja startu łagodnego:

Wcisnąć lekko przycisk , wejść do statusu startu łagodnego, przycisk  diody LED po lewej u góry będzie aktywny (świeci się). Wcisnąć ponownie ten przycisk, aby wyjść ze statusu startu łagodnego, przycisk  diody LED po lewej u góry będzie wyłączony.



2.1.4 Nacisnąć przycisk podnoszenia stopki:

Użyć przycisku : wybrać status podnoszenia stopki; są cztery różne statusy, brak automatycznego podnoszenia stopki, tj. , automatyczne podnoszenie stopki po lamówkowaniu, tj. , automatyczne podnoszenie stopki w razie zatrzymania szycia, tj. , automatyczne podnoszenie stopki przy lamówkowaniu i zatrzymaniu szycia, tj. . Użyć przycisku , aby wybrać, a dioda LED na górze pokaże odpowiedni status.



2.1.5 Przycisk lamówkowania:

Użyć przycisku : wybierz/odznacz lamówkowanie automatyczne. Dioda LED po lewej u góry przycisku lamówkowania będzie świecić, jeśli wybrane jest automatyczne lamówkowanie, jak , w przeciwnym razie dioda LED jest wyłączona, tj. .

2.1.6 Przycisk szycia one-shotem

Użyć przycisku : wybierz/odznacz szycie one-shot. Dioda LED po lewej u góry przycisku szycia one-shot będzie świecić się, jeśli wybrane jest szycie one-shot przy włączonej opcji multisegmentowej, jak ; , w przeciwnym razie dioda LED jest wyłączona, tj. .

2.1.7 Przycisk pozycji zatrzymania

Użyć przycisku : wybrać pozycję zatrzymania góra/dół. Dioda LED po lewej u góry przycisku lamówkowania będzie świecić się, jeśli wybierze się dolną pozycję igły; Dioda LED jest wyłączona, jeśli wybrana jest pozycja górna igły, tj. .

2.2 Tryb technika



W tym trybie parametry techniczne odpowiadające różnym funkcjom można ustawiać lub resetować zgodnie z potrzebą, aby system pracował w jak najlepszym stanie. Ustawienie parametrów w trybie technika:

Krok 1: W trybie operatora nacisnąć przycisk  i przycisk, dioda LCD pokaże PD - 0000, a następnie technik musi ustawić hasło. Hasło domyślne to 0000, a wyświetlacz LCD

to .

Krok 2: Użyć przycisków  (6-13), aby wprowadzić hasło, następnie

wcisnąć przycisk . Jeśli hasło jest prawidłowe, wejdzie do trybu technika. W przeciwnym razie wróci do trybu operatora.



Krok 3: Zmienić parametry technika przyciskami  (4, 5) i przyciskiem . Parametry są pokazane w tabeli 2.

Krok 4: Wartości parametrów można zmienić za pomocą przycisków  (6-13).

Krok 5: W trybie technika wcisnąć przycisk , panel wróci do trybu operatora.

Tabela 2: Parametr trybu technika:

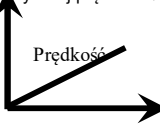
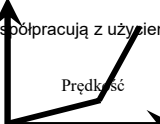
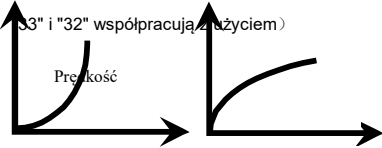
	Parametr Bajt wysoki	Parametr Bajt niski	Domyślne	Zakres	Uwaga
startu	0	0	200	100 ~800	Minimalna prędkość szycia
		1	3500	200 ~5000	Maksymalna prędkość szycia
		2	3000	200 ~5000	Maksymalna stała prędkość szycia
		3	3000	200 ~5000	Maksymalna prędkość ręcznego lamówkowania w tył
		4	200	100 ~800	Prędkość kompensacji ściegu
		5	250	100 ~500	Prędkość lamówkowania
		6	0	0 / 1	Konfiguracja trybu łagodnego startu: 0: Łagodny start dopiero po lamówkowaniu 1: Łagodny start po lamówkowaniu i zatrzymaniu
		7	2	1 ~4	Prędkość numeru ściegu łagodnego
		8	200	100 ~800	Prędkość łagodnego startu
		9	13	1 ~20	Czułość przyspieszenia systemu (Bezpośrednie przeniesienie napędu można ustawić na wysoką wartość; przenoszenie taśmowe - nie ustawiać wysokiej wartości albo zbyt dużego hałasu i wibracji. Parametr ten nie ma wpływu elektrycznego)
		A	13	1 ~20	Czułość spowolnienia systemu (Bezpośrednie przeniesienie napędu można ustawić na wysoką wartość; przenoszenie taśmowe - nie ustawiać wysokiej wartości albo zbyt dużego hałasu i wibracji. Parametr ten nie ma wpływu elektrycznego)
Konfiguracja fastrygowania w tył	1	0	1800	200 ~3000	Prędkość startu fastrygowania w tył
		1	1800	200 ~3000	Prędkość końca fastrygowania w tył
		2	1800	200 ~3000	Prędkość stała fastrygowania w tył
		3	20	0 ~70	Kompensacja ściegu startu fastrygowania w tył 1
		4	20	0 ~70	Kompensacja ściegu startu fastrygowania w tył 2
		5	20	0 ~70	Kompensacja ściegu końca fastrygowania w tył 1
		6	20	0 ~70	Kompensacja ściegu końca fastrygowania w tył 2

	Parametr Bajt wysoki	Parametr Bajt niski	Domyślne	Zakres	Uwaga
Pedal	3	0	0	0/1/2/3	Konfiguracja pedału trybu krzywej: 0: Obliczona automatycznie krzywa liniowa (Zgodnie z automatycznym obliczeniem na wyższej prędkości)  Kąt pedału do przodu
					1: Krzywa liniowa dwusegmentowa. (Możesz swobodnie ustawić wolny start po szybkim lub szybki start po wolnym, parametry "31" i "32" współpracują z użytkowaniem)  Kąt pedału do przodu
					2: Krzywa arytmetyczna (parametry "33" i "32" współpracują z użytkowaniem)  Kąt pedału do przodu
					3: krzywa S (sterowanie operacyjne jest bardzo dobre, wolny start po szybkim)  Kąt pedału do przodu

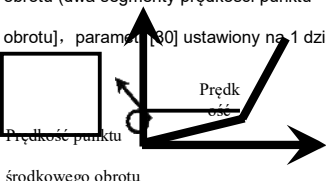
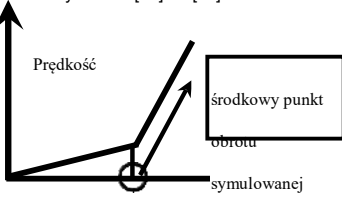
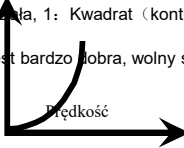
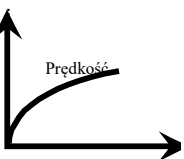
	Parametr Bajt wysoki	Parametr Bajt niski	Domyślne	Zakres	Uwaga
		1	3000	200~4000	<p>Dwa segmenty sterują nachyleniem prędkości: prędkość RPM środkowego punktu obrotu (dwa segmenty prędkości punktu obrotu), parametr [30] ustawiony na 1 działa.</p>  <p>Prędkość punktu</p> <p>Prędkość</p> <p>Kąt pedału do przodu</p>
		2	800	0~1024	<p>Dwa segmenty sterują nachyleniem prędkości: środkowy punkt obrotu symulowanej wartości pedału, parametr[30] ustawiony na 1 działa, wartość wynosi od [38] do [39].</p>  <p>Prędkość</p> <p>Prędkość</p> <p>środkowy punkt obrotu</p> <p>symulowanej wartości pedału</p> <p>Kąt pedału do przodu</p>
		3	1	1~2	<p>Parametr uzupełniający krzywej arytmetycznej: parametr[30] ustawiony na 2 działa, 1: Kwadrat (kontrola niskiej prędkości jest bardzo dobra, wolny start po szybkim);</p>  <p>Prędkość</p> <p>Kąt pedału do przodu</p> <p>2: Pierwiastek kwadratowy (Prędkość odpowiedzi jest wysoka, szybki start po wolnym)</p>  <p>Prędkość</p> <p>Kąt pedału do przodu</p>

	Parametr Bajt wysoki	Parametr Bajt niski	Domyślne	Zakres	Uwaga
		4	50	0~1024	Ustawiona pozycja pedału lamówkowania, zob. 2-1. (wartość nie jest wyższa niż parametr [30].)
		5	300	0~1024	Podnoszenie stopki dociskowej, zob. 2-1. (wartość między[34]a[36].)
		6	450	0~1024	Pozycja tylna środkowa pedału, zob. 2-1. (wartość między[35]a[37].)
		7	480	0~1024	Pedał w pozycji biegu, zob. 2-1. (wartość między[36]a[38].)
		8	580	0~1024	Pozycja pedału biegu niskiej prędkości (górną), zob. 2-1 (wartość między[37]a[39].)
		9	550	0~1024	Symulacja najwyższej wartości pedału, zob. 2-1 (wartość nie jest niższa niż parametr [38].)
		A	100	0~800	Czas potwierdzenia pedału podniesienia stopki dociskowej
konfiguracja niestandardowa	4	0	1	0 / 1	Powrót do górnej pozycji igły po włączeniu zasilania: 0: brak działania 1: działanie
		1	1	0 / 1	Wybór funkcji automatycznego wzmocnienia : (głowica maszyny nie wzmocnia automatycznie funkcji, najlepszy sposób to zakaz) 0: zakaz 1: dozwolone
		2	0	0 / 1	Powrót do szycia ręcznego, gdy wybrany jest tryb funkcji: 0: tryb Juki. Podczas szycia lub na koniec działania 1: tryb Brother. Działa tylko w przypadku szycia.
		3	0	0 / 1 / 2 / 3	Konfiguracja specjalnego trybu pracy: 0: wybór operatora 1: tryb szycia prostego 2: obliczyć kąt początkowy silnika (nie demontować paska) 3: obliczyć tryb prędkości głowicy silnika/maszyny (synchronizator, nie demontować paska)

	Parametr Bajt wysoki	Parametr Bajt niski	Domyślne	Zakres	Uwaga
		4	0	0—31	Zwiększenie momentu obrotowego przy niskiej prędkości : 0: brak działania 1~31: 31 poziomów zwiększania momentu obrotowego
		5	1	0 / 1	Tryb zatrzymania szpilki: 0: Tryb stałej prędkości fastrygowania (w przeniesieniu, zatrzymanie nie jest precyzyjne) 1: tryb ciągnięcia w tył (PMX)
		6	150	0~800	Przycisk poleceń, aby wprowadzić połowę czasu igły
		7	180	0~800	Przycisk poleceń, aby wprowadzić czas igły
Działanie	6	1	0	0 / 1 / 2	Parametr przekładania 0: brak działania 1: Pobierz parametry (panel będzie parametr z panelu do sterownika) 2: Wgraj parametry (panel będzie miał parametry ze sterownika do panelu)
		2	0	1, 2, XXXX	Przywrócić parametr przechowywania(Przywróć tylko parametry operatorom i sprzedawcom oraz konserwację) Pasek płaski 1000/ Bezpośredni napęd płaski 2000
		3	0	1, 2	Zapasowy parametr bieżący jako parametr użytkownika dla przywrócić (przywróć)
		Uwaga: Ponad tym parametrem „6x” pracy nie jest zapisane.			

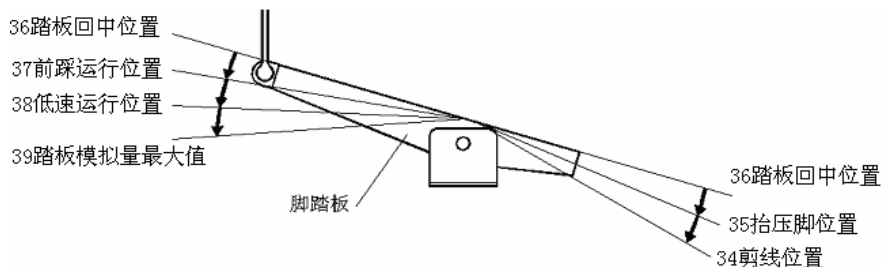

Rys. 2-1 Parametr działania pozycji pedału – schemat

2.3 Trybu administratora



W trybie tym różne ustawienia parametrów elektromagnesów można regulować zgodnie z potrzebą, aby system serwo mógł działać normalnie w każdej maszynie do szycia. Ustawienie parametrów w trybie technika:

Krok 1: W trybie operatora nacisnąć przyciski  , aby wejść do trybu administratora w LCD PD-0000,

Hasło domyślne to **0000**, a wyświetlacz LCD to .

Krok 2: Hasło wprowadza się za pomocą przycisków  (6-13), a następnie

wcisnąć przycisk . Jeśli hasło jest prawidłowe, wejść do trybu technika lub wrócić do trybu operatora.

Krok 3: Zmienić parametry indeksu administratora  przyciskami  (4, 5) i przyciskami  w trybie administratora. Szczegóły parametrów technicznych pokazany jest w tabeli 3.

Krok 4: Wartości parametrów można zmienić za pomocą przycisków  (6-13).

Krok 5: W trybie administratora wcisnąć przycisk , panel wróci do trybu operatora.



Tabela 3: Parametr trybu administratora:



	Parametr Bajt wysoki	Parametr Bajt niski	Domyślne	Zakres	Uwaga
Tryb lamówkowania	0	2	1	0 / 1 / 2 / 3	Wybór trybu dla sekwencji lamówkowania. 0: Zgodnie z parametrami 【03】 ustawiony kąt wynosi lamówkuje, aż do wyłączenia czasu opóźnienia pozycji 【06】 . 1: Zgodnie z parametrami 【03】 ustawionego kąta lamówkuje aż 【04】 ustawione kąty wyłączą się. 2: Zgodnie z parametrami 【03】 ustawiony kąt lamówkuje, opóźnienie 【06】 wyłączenia. 3: Sygnał pozycji dolnej opóźnił parametr 【05】 ustawione kąty lamówkowania, opóźniło wyłączenie 【06】 .
		3	10	5-35	Kąty startowe lamówkowania (względna dolna pozycja kąta)



	Parametr Bajt wysoki	Parametr Bajt niski	Domyślne	Zakres	Uwaga
		4	180	10-35	Kąty końcowe fastrygowania (względna dolna dolna pozycja kąta, potrzebna większa niż system parametrów 【03】)
		5	10	1-999	Czas opóźnienia startu lamówkowania T1 (ms)
		6	60	1-999	Czas opóźnienia końca lamówkowania T2 (ms)
Zwolnienie naciągu Tryb czyszczenia i zacisku	1	0	0	0 / 1 / 2 / 3 / 4	Wybór trybu dla sekwencji zwolnienia napięcia: 0: Zgodnie z parametrami 【11】 ustawiony kąt to zwolnienie napięcia aż czas końca czasu opóźnienia pozycji górnej 【14】. 1: Zgodnie z parametrami 【11】 ustawiony kąt wynosi zwolnienie napięcia do ustawienia wyłączenia kątów 【12】. 2: Zgodnie z parametrami 【11】 ustawiony kąt to zwolnienie napięcia, opóźnia wyłączenie 【14】. 3: Sygnał pozycji dolnej opóźni ustawione kąty parametru 【13】, lamówkuje, opóźniło to wyłączenie 【14】 【14】. 4: Sygnał pozycji górnej opóźni parametr 【13】 ustawione kąty lamówkowania, opóźniło wyłączenie 【14】.
		1	25	5-35	Kąty startowe zwolnienia naciągu (względna dolna pozycja kąta)
		2	300	10-35	Kąty końcowe zwolnienia naciągu (względna dolna pozycja kąta, potrzebna większa niż system parametrów 【11】)
		3	1	1-999	Czas opóźnienia startu zaworu elektromagnetycznego zwalnającego naciąg T1 (ms)
		4	10	1-999	Czas opóźnienia pozycji górnej zaworu elektromagnetycznego zwalnającego naciąg T2 (ms)
		5	1	0 / 1	wybór funkcji czyszczenia 0: wyłącz. 1: włącz.
		6	10	1-999	Czas opóźnienia zacisku / czyszczenia ms
		7	30	1-999	Czas wstrzymania zacisku / czyszczenia ms

	Parametr Bajt wysoki	Parametr Bajt niski	Domyślne	Zakres	Uwaga
		8	50	1 - 999	Czas powrotu zacisku /czyściwa ms
		9	0	0 / 1	Funkcja zacisku nici: 0: wyłącz. 1: włącz.
		A	100	0 - 350	Kąt startowy zacisku
		B	210	0 - 350	Kąt końca zacisku
Tryb zatrzymania	3	1	0	0 / 1	Wybór trybu testu automatycznego : 0: ustaw ściegi 1: ustaw czas
		2	300	0 ~1000	Czas alarmu bezpieczeństwa SW ms (w taki sam sposób nie rozróżnia między napędem bezpośrednim SW bezpieczeństwa i blokadą SW zabezpieczenia lamówkowania płaskiego)
		3	50	0 ~1000	Czas potwierdzenia przywrócenia SW bezpieczeństwa ms
		4	0	0 / 1	Konfiguracja kierunku obrotów silnika: 1: W przód 0: W tył
Parametr głowicy maszyny	4	0	1000	0 - 9999	zużycie głowicy silnika/maszyny: 0.001 (jeśli automatyczne obliczenie zużycia głowicy silnika/maszyny zostało przeprowadzone, wartość parametru w skrzynce kontrolnej może być inne niż ta w HMI)
		2	0	0 - 35	Wyregulowany kąt pozycji górnej igły (porównać z górną pozycją przesunięcia pozycji czujnika)
		3	175	0 - 350	Kąt pozycji dolnej mechanicznej igły
		4	1	1 - 800	Czas opóźnienia docisku (ms)

2.4 Numer wersji HMI i tryb modyfikacji jego parametrów

W czasie czuwania HMI, wcisnąć przycisk , następnie wcisnąć przycisk , wejść do interfejsu wprowadzania numeru wersji wyświetlacza HMI, np.

jak na rysunku . HMI wraca do stanu czuwania, jeśli wciśnie się  lub nie wciśnie przycisku po czasie regulacji.

Po wprowadzeniu interfejsu numeru wersji wyświetlacza HMI, po wciśnięciu przycisku , wcisnąć przycisk , HMI może wejść

0.10.20.0.0. Może być używany do modyfikowania indeksu parametrów i ustawiania wartości za pomocą liczby ustawianej klawiszami w górę i dół. Określając zgodne parametry, nacisnąć przycisk , aby określić modyfikację. HMI powraca do stanu czuwania, jeśli nie wciśnie się przycisku po czasie regulacji.

Tabela 2: Parametr HMI

Numer indeksu parametru	UWAGA
01	zatrzymać
02	zatrzymać
03	zatrzymać
04	zatrzymać
05	zatrzymać
06	W każdym stanie, jeśli zwyczajem nie jest naciśnięcie przycisku w określonym czasie, automatycznie wyjdzie do stanu czuwania HMI, regulacja indeksu parametru 06 czasu oczekiwania. Zakres regulacji 2 ~ 10.
07	zatrzymać

2.5 Tryb monitora





W czasie czuwania HMI, wciśnięcie przycisk , następnie wciśnięcie przycisk , wejść do trybu monitora. Użyć przycisków  (4、5) i przycisków  w celu przełączenia, aby obejrzeć parametry. W kwestii parametru monitora zob. arkusz 5, HMI wróci do stanu czuwania, jeśli nie ma działania po czasie regulacji.

Tabela 5: Parametr trybu monitora

	Parametr Bajt wysoki	Parametr Bajt niski	Jednostka	uwaga
Status monitora	1	0		Licznik ściegów
		1		Licznik lamówkowania
	2	0	V	Napięcie magistrali DC
		1	RPM	Prędkość silnika
		2	0.01A	Prąd jednofazowy
		3	stopień	Kąt początkowy

		4	stopień	Kąt mechaniczny
		5	—	Wartość próbkowania napięcia pedału
		6	0.001	poziom pracy głowicy silnika/maszyny
		7	godzina	Łączny czas pracy silnika
		8	—	Wartość próbkowania potencjometru na głowicy maszyny
3	0 - 7	—	Rejestr kodu błędu historii 8	

2.6 Tryb złego ostrzeżenia

Jeśli HMI wykrywa, że jest coś nie tak z kontrolerem, przeskoczy automatycznie do trybu ostrzegawczego i

pokazać kod błędu, zob. . W trybie złym ostrzeżenia użytkownik może ustawić

zmiana parametrów technika, parametr administratora i samodzielna zamiana parametru HMI lub trybu monitora. Wyjść z tych trybów nie z powrotem do stanu czuwania, ale powrócić do trybu ostrzegania o złym trybie. Przywróci normalny status po naprawieniu błędu i zresetowaniu mocy.

2.7 Tryb wstawiania paneli zewnętrznego

Po włożeniu zewnętrznego interfejsu HMI, to HMI przestanie działać, a lampka cyfrowa i wszystkie diody LED będą świecić.

Po wyciągnięciu panelu zewnętrznego po około 2 sekundach panel znów zaczyna pracować.

3 System sterowania przywraca parametr pamięci

3.1 Przywrócenie parametru pamięci dla sterowania fabryki

Krok 1: W trybie operatora wcisnąć przycisk  i , LCD **PD-0000**; użytkownik musi wpisać hasło.



Krok 2: Hasło wprowadza się za pomocą przycisków  (6-13), a następnie wcisnąć przycisk . Jeśli hasło jest prawidłowe, wejść do trybu technika lub wrócić do trybu operatora.

Krok 3: Zmienić indeks parametrów administratora na **【62】** przyciskami  (4, 5) i

przyciskami  w trybie technika. Przywrócenie parametru pamięci dla sterowania fabryki można zmienić poprzez





przyciski (6-13), zwykle są cztery poprawne bity.



Etap 4: parametr potwierdzony prawidłowy, wcisnąć przycisk  aż dioda LED zacznie migać, puścić przycisk , HMI i cały system przywraca parametr pamięci.

3.2 Przywrócenie własnego parametru domyślnego użytkownika

Parametr **【63】** HMI może służyć do ustawiania własnych parametrów klienta, zgodnie z metodami działania :

Krok 1: W trybie operatora wcisnąć przycisk  i  , LCD **PD-0000**; użytkownik musi wpisać hasło.

Krok 2: Hasło wprowadza się za pomocą przycisków  (6-13) , następnie wcisnąć przycisk  . Jeśli hasło jest prawidłowe, wejść do trybu technika lub wrócić do trybu operatora.

Krok 3: Zmienić parametry indeksu administratora na **【62】** przyciskami  (4、5) i  i przyciskami w trybie technika. Wartość zmieniać na 1 lub 2 przyciskami  (9、13).

Uwaga: Jeśli jest ustawiony na 1, gdy chcesz przywrócić parametr, wprowadź indeks **【62】** i ustaw parametr 1; gdy jest ustawiony na 2, wprowadzić parametr do indeksu **【62】**, ustawić 2.

Krok 4: Nacisnąć przycisk , przytrzymać przez 5 sekund, HMI i cały system przywróci ustawiony bieżący parametr i da użytkownikowi możliwość dostosowania parametru pamięci.

Gdy parametr powoduje błąd systemu sterowania, użytkownik może przywrócić parametry niestandardowe, metody działania jako "4.1 Przywrócenie parametru pamięci dla sterowania fabrycznego".

Parametr **【62】** jest zmieniony 1 lub 2. Nacisnąć przycisk , przytrzymać przez 5 sekund, system przywróci użytkownikowi możliwość dostosowania parametru pamięci.

Uwaga:

- 1、 Po włączeniu zasilania HMI pobiera tylko parametr **trybu operatora**, ale nie parametr **technika** ani **administratora**.
Jeśli potrzebne są wszystkie parametry, parametr **technika** 61 można użyć do pobrania całego bieżącego parametru roboczego HMI 50.
- 2、 W razie przywrócenia innego parametru zapisu HMI, **technik** 62 może być użyty do utworzenia bieżącego parametru roboczego i inicjatywy pobierania.
- 3、 Po modyfikacji pojedynczego parametru HMI pobierze wartość inną od starej wartości parametru.
- 4、 Przywrócić parametry domyślne, najlepiej ponownie wyczyścić system.

386P00480

2011-11-8

A 版